

*Yol ve Trafik
Güvenliğinde
Kalitenin Adresi*



www.ermak.com.tr

e-mail: ermak@ermak.com.tr





Ermak İnşaat Mak. San. Tic. ve Turizm Ltd. Şti, trafik ve yol güvenliği hizmetleri vermek amacıyla 1996 yılında kurulmuştur.

Trafik işaretleri, yüksek görünürlüğü olan kıyafetler ve yüksek teknoloji gerektiren çözümler adı altında trafik, güvenliği ürünlerinin imalat ve servisini yapan bir şirkettir.

Trafik ve yol güvenliği konusundaki yoğun tecrübenin getirdiği liderlikle, endüstrinin önemli imalatçı ve tedarikçilerinden biridir.

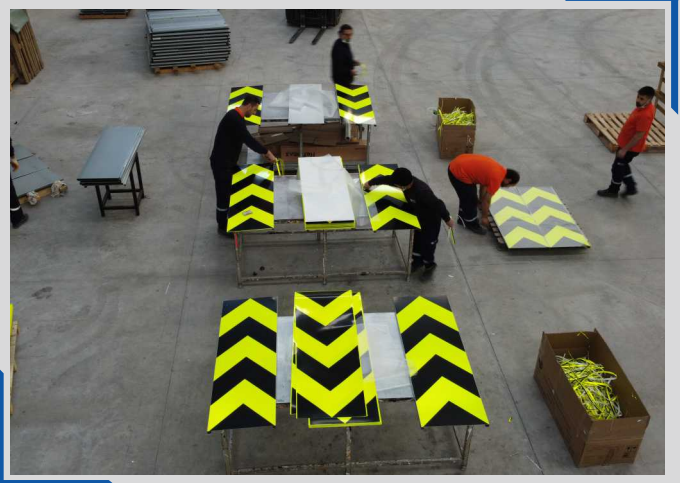

HİZMET KONULARIMIZ

- TRAFİK İŞARET LEVHALARI
- YOL BUTONLARI
- OTOKORKULUK REFLEKTÖRLERİ
- TRAFİK EMNİYET KONİLERİ
- OMEGA TRAFİK İŞARET DİREĞİ
- REFLEKTİF MALZEME
- CTP YOL KENAR DİKMELERİ
- GÜNEŞ ENERJİLİ TRAFİK İŞARETLERİ
- PLASTİK BARIYERLER
- YÜKSEK GÖRÜNÜRLÜĞE SAHİP İŞ GÜVENLİĞİ KIYAFETLERİ
- KAR DİREKLERİ
- KARAYOLU TRAFİK PROJESİ YAPIMI

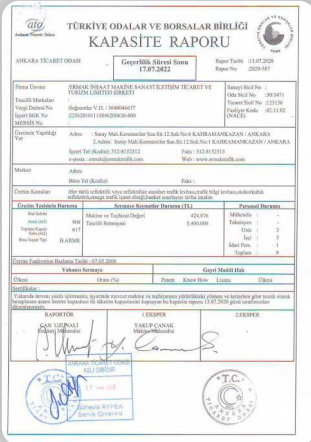
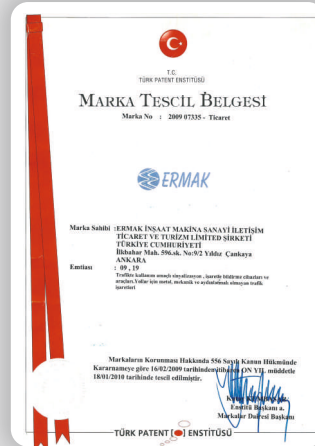

İÇİNDEKİLER



- HAKKIMIZDA
- TRAFİK LEVHALARI ÜRETİMİ

4-7



- REFLEKTİF MALZEME
- GALVANİZLİ OMEGA DİREK
- KAR DİREĞİ

8-9



- BANKET SINIRLAYICI LEVHA
- CTP YOL KENAR DİKMESİ
- RÜZGAR ÇORABI
- SU BARIYERİ

10-12

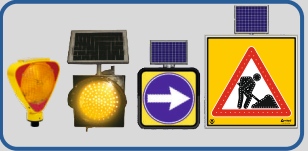

- GÜNEŞ ENERJİLİ FLAŞÖRLER
- GÜNEŞ ENERJİLİ LEVHALAR
- GÜNEŞ ENERJİLİ YOL BAKIM ONARIM LEVHALARI
- LEDLİ BİLGİ LEVHALARI

13-25



- DUBALI UYARI DİKMELERİ
- KATLANIR UYARI LEVHALI BARIYERLER

26-30



- GÜVENLİK BARIYERLERİ
- GÜVENLİK BARIKATLARI
- LEVHALI VE PORTATİF DUBALAR

31-33



- PVC TRAFİK KONİLERİ
- ULTRA VE KLASİK TRAFİK KONİLERİ
- TRAFİK KONİLERİ STANDART SERİ

34-35

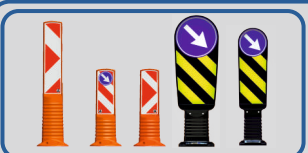

- LEVHALI OTOYOL DİKMESİ
- REFÜJ BAŞI LEVHALARI

36



- ŞERİT AYIRICI ESNEK DELINEATORLER
- REFÜJ DUBALARI

37-39



- DELINEATORLÜ ŞERİT DÜZENLEME BUTONLARI

40

İÇİNDEKİLER



•ŞERİT SINIRLAMA BUTONLARI

41

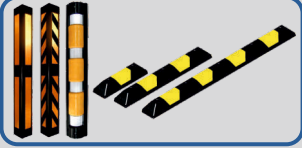

•ARAÇ STOPERLERİ
•OTOPARK KOLON KÖŞE KORUYUCULARI

42



•TRAFİK GÜVENLİK AYNALARI
•GÜVENLİK KIYAFETLERİ

43-44



•OTOPARK KASIS KAPANI
•KABLO KORUYUCU KASIS
•HIZ KESİCİ KASISLER

45-46



•CAM KEDİ GÖZLÜ YOL BUTONLARI
•MERCEKLİ YOL BUTONLARI
•GÜNEŞ ENERJİLİ YOL BUTONLARI

47-48



•EL TİPİ UYARICI İŞARETLERİ
•EMNİYET ŞERİDİ-STOPPER-GRİLLANT
•REFLEKTÖRLER

49-50

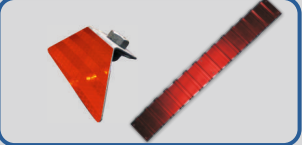

•OTOKORKULUK REFLEKTÖRLERİ
•GENİŞ AÇILI PRİZMATİK REFLEKTÖRLER

51

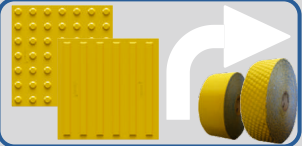

•GÖRME ENGELLİLER İÇİN ZEMİN İŞARETİ
•YAPIŞKANLI ZEMİN İŞARETLEME BANTLARI

52-55



•REFLEKTİF BANTLAR
•DİKDÖRTGEN ÜÇGEN VE YUVARLAK
UYARI LEVHALARI
•VİDALAR DÜBELLER ZİNCİRLER

56-57



•STANDART TRAFİK LEVHALARI KOD LİSTESİ

58-62

Trafik Levhaları Üretim



Trafik işaretleri, yüksek görünürlüğü olan kıyafetler ve yüksek teknoloji gerektiren çözümler adı altında trafik, güvenlik ve emniyet ürünlerinin imalat ve servisini yapan bir şirkettir.

ERMAK trafik ve yol güvenliği hizmetleri vermek amacıyla 1996 yılında kurulmuştur.

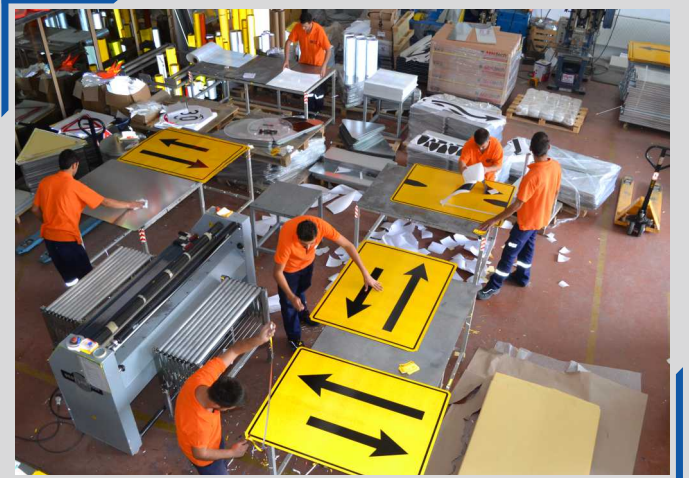
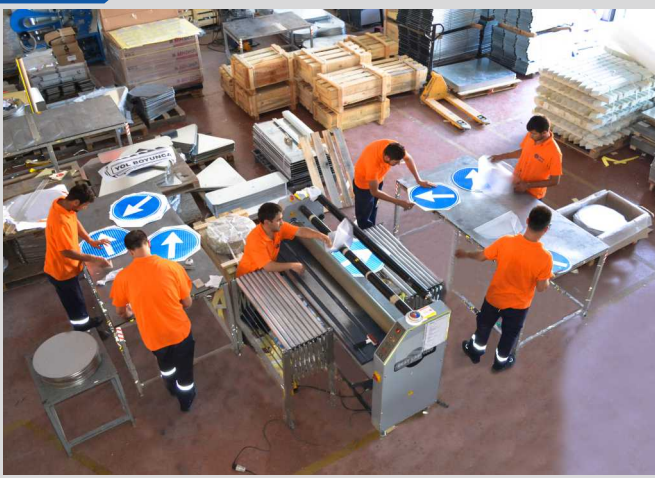

Trafik Levhaları Üretim



Trafik ve yol güvenliği konusundaki yoğun tecrübenin getirdiği liderlikle, endüstrinin önemli imalatçı ve tedarikçilerinden biridir.



ISO 9001-2008 belgeli bir kuruluş olmanın bilinci içinde, Ar-Ge çalışmalarına önemli ölçüde yer vererek konusunda liderliği hedeflemektedir.



Ermak'ın hedeflediği vizyon; şirketin sahip olduğu ürün portföyünü imalat, proje ve yetkin çözümlerle geliştirerek ülkemiz ve dünya hizmetine sunmaktır.



Trafik Levhaları Üretim



Dünya Standartlarına Uygun Üretim

Ermak Trafik ulusal ve uluslararası standartlara uygun ürün kalitesi ile zamanında, doğru ve güvenilir şekilde müşteri taleplerini karşılamaktadır.

Kalite

Ermak Trafik, ISO 9001:2008 belgeli üretim tesisindeki, yüksek standartlar sayesinde müşterilerine sürekli olarak gerçek kaliteyi sunmaktadır.

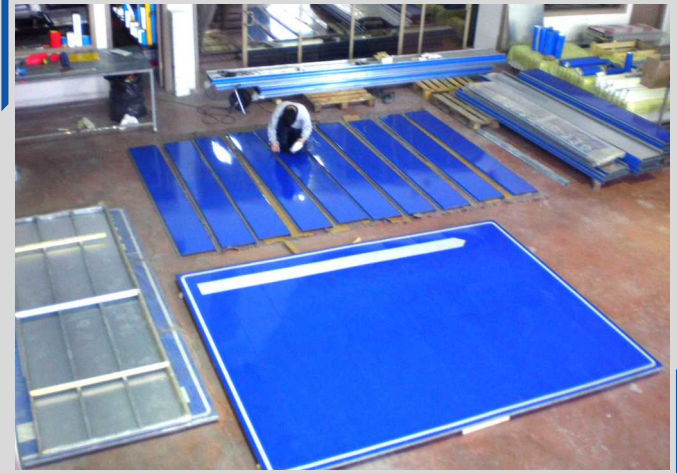
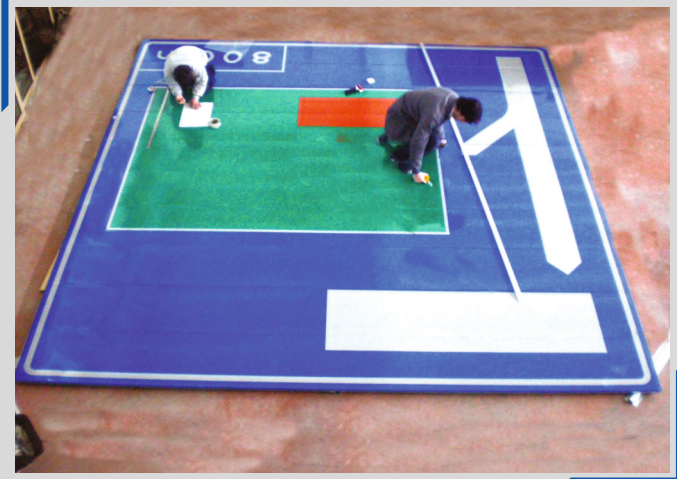

Trafik Levhaları Üretim

Uzman Personel

Ermak Trafik, trafik malzemeleri üretimi konusunda uzman personeli ile birlikte müşteri memnuniyetini ön planda tutarak titiz, özverili ve kalite odaklı çalışmaktadır.



Özenli Üretim - Hızlı Teslimat

Ermak Trafik müşterilerinin siparişlerini stoktan en hızlı şekilde sevk eder. Bu durum müşterilerinin güvenini ve zamandan kazanmasını sağlar.



Omega Levha Direği

- Omega levha direkleri, standart trafik işaretleri ve köy isim levhalarını banket sınırına monte etmek için kullanılan direklerdir.
- Sıcak daldırma galvaniz uygulanmaktadır.
- Direk ölçüleri, kullanılacak levhanın ölçülerine göre değişiklik göstermektedir.
- İstenilen ölçülerde imal edilebilmektedir.

- Malzeme : Galvanizli Omega Profili
- Ölçüler : 3mm/ 2,5 mt - 3mt
4mm/ 2,5 mt - 3mt
5mm/ 3,5 mt - 4mt
- Delik Ölçü : Ø 10
- Delik Aralık : 20mm

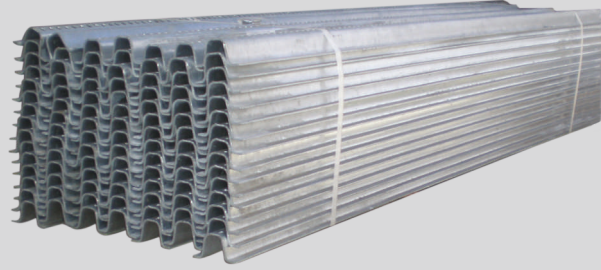

E 220 00

Kar Direği

- Karayollarının yoğun olarak kar tutan kesimlerinde, yol sınırını belirlemek amacı ile kullanılır.
- Üzerine yüksek performanslı reflektif malzeme uygulanmaktadır.

- Malzeme : Demir Boru
- Renk : Siyah-Turuncu- Beyaz
- Uzunluk : 3mt.
- Çap : 2 inch - 2,5 inch

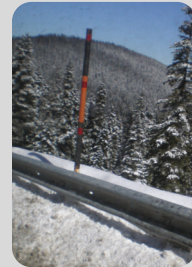

E 127 KD

Banket Sınırlayıcı



- Panel Ölçü : 200mm x 400mm
- Panel Malzeme : Galvanizli Sac,
- Ayak Malzeme : İnşaat demiri
(Beyaz Boyalı)
- Uygulama : Beyaz N.P. çift yönlü
reflektif üzerine
kırmızı serigrafi
boyası tatbik edilmiştir.



E 137 BS

Rüzgar Çorabı

- Rüzgar yönünün tayin edilmesinde kullanılır.
- İstenilen boy ve renkte üretilebilir.
- Reflektif kumaş üzerine istenilen baskı yapılabilir.
- Tulum Çapı : 400 mm - 600mm
- Tulum Uzunluk : 2000 mm- 2400mm
- Tulum Malzeme : Floresan Kumaş - Saten Kumaş
- Tulum Renk : Turuncu- Kırmızı/Beyaz



E 131 RG

RÜZGAR ÇORABI

CTP Yol Kenar Dikmesi



E 147 CTP B



E 148 CTP S

Montaj Aparatı



E 146 CTP Ç

- Üzerine yapıştırılan reflektif malzeme, sürücülere gece görüş imkanı sağlar.
- Isı değişikliklerine karşı dayanıklıdır.
- Araç darbelerine karşı eski durumunu korur.
- Bakım giderlerini tamamen ortadan kaldırır.
- Bir başka imalat için hammadde olarak kullanılamaz.
- Herhangi bir aracın darbesinde araca zarar vermez.
- Yanma özelliği ve hurda değeri yoktur.
- Özel montaj aleti sayesinde kolay ve hızlı monte edilebilmektedir.
- Gövde : Cam Elyafli Polyester
- Genişlik : 100 mm
- Kalınlık : 3 mm
- Standart Uzunluk : 1300mm
- Eğrilik : 10 - 13 mm
- Reflektif Boyutu : 150x70 mm
- Standart Renk : Sarı - Beyaz



Su Bariyerleri

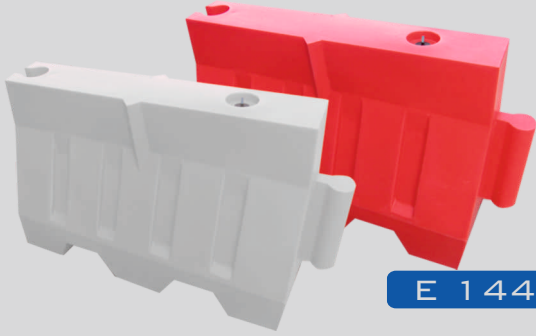

E 144 SB K

E 144 SB B

SU BARIYERİ

- Malzeme : Plastik
- Renk : Beyaz-Kırmızı
- Uzunluk : 1200 mm
- Genişlik : 500 mm
- Yükseklik : 800 mm
- Boş Ağırlık : 15 kg
- Hacim : 275 lt

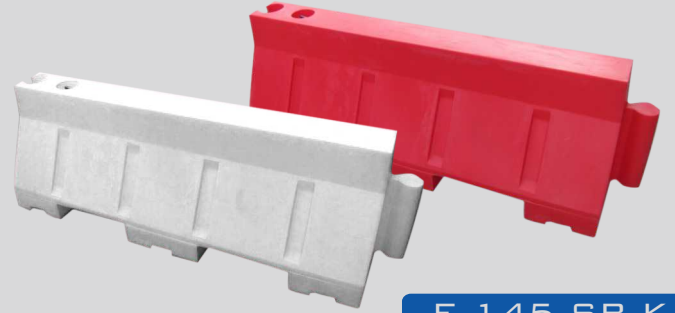

E 145 SB K

E 145 SB B

SU BARIYERİ

- Malzeme : Plastik
- Renk : Beyaz-Kırmızı
- Uzunluk : 1500 mm
- Genişlik : 500 mm
- Yükseklik : 500 mm
- Boş Ağırlık : 14 kg
- Hacim : 150 lt



E 275 SB K

E 275 SB B

SU BARIYERİ

- Malzeme : Plastik
- Renk : Beyaz-Kırmızı
- Uzunluk : 1200 mm
- Genişlik : 500 mm
- Yükseklik : 500 mm
- Boş Ağırlık : 14 kg
- Hacim : 80 lt



Otoyollarda, devlet ve il yolları ile şehir içi yollarda trafik güvenliğini sağlamak amaçlı, gerekli olan kesimlerde kullanılmaktadır.

Güneş Enerjili Flaşörler



11811 FL S

Flaşörlü Uyarı Lambası
(İki Yönlü)



11813 FL K

Flaşörlü Uyarı Lambası
(İki Yönlü)



11827 FL K

Flaşörlü Uyarı Lambası
(Tek Yönlü)



11825 FL S

Flaşörlü Uyarı Lambası
(Tek Yönlü)



11814 FL S

Flaşörlü Uyarı Lambası
(Çift Yönlü)



11816 FL K

Flaşörlü Uyarı Lambası
(Çift Yönlü)



11817 FL K

Flaşörlü Uyarı Butonu



11819 FL S

Flaşörlü Uyarı Butonu



11821 FL M

Flaşörlü Uyarı Butonu

Teknik Özellikler

Solar Panel	Tip	monocrystalline silicon cell
	Ölçü	120 x 45 mm
	Voltaj	4.3 V
Batarya	Akım	80 mA
	Malzeme	Ni-MH
	Voltaj	2x1.2 V
LED	Akım	2300 mA/h
	Renk	Sarı-Kırmızı-Mavi
	Ölçü	Ø5 mm
	Flaş Sayısı	105 f/dk
	Uyarı Mesafesi	500 m gecede
	Çalışma Süresi	Gün ışığında şarj ile tüm gece
	Çalışma Sıcaklığı	-20°C / +60°C

Teknik Özellikler

Ürün Kodu	11811 FL S	11813 FL K	11827 FL K	11825 FL S	11817 FL K	11819 FL S	11821 FL M	11814 FL S	11816 FL S
Ölçü (Ø x H)	90x235x290	90x235x290	90x215x290	90x215x290	(ØxH)128x145	(ØxH)128x145	(ØxH)128x145	80x220x270	80x220x270
Ağırlık(yaklaşık)	0.840 kg	0.840 kg	0.750 kg	0.750 kg	0.600 kg	0.600 kg	0.600 kg	0.500 kg	0.500 kg
Malzeme	PC-ABS				PC-PA			PC-ABS	
Özellikler	Açma-Kapama Düğmesi				-			Açma-Kapama Düğmesi	
	Çift Yönlü Uyarı / 4+4 LED		Tek Yönlü Uyarı / 8 LED		Dairesel Uyarı / 6 LED			Çift Yönlü Uyarı / 2+2 LED	
Koruma Sınıfı	Gövde Sızdırmazlık IP 54 Özelliğine Sahip								
Belgelendirme	DIN EN ISO 9001:2008								
Uygulama	Evelux konilere, delineatorlere bariyerlere ve dikmelere uygulanabilir								

Güneş Enerjili Flaşörler

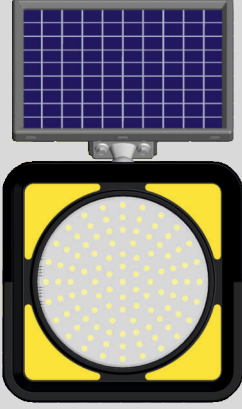

11850 FL S
Solar Flaşörlü Lampa
Ø 300 mm

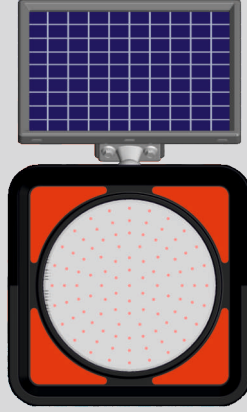

11852 FL K
Solar Flaşörlü Lampa
Ø 300 mm

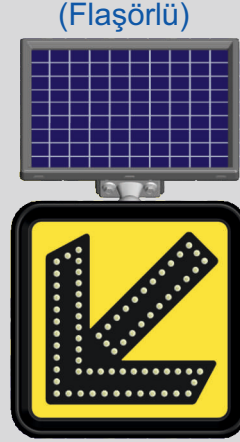

(Flaşörlü)
11860 FL S
Soldan Gidiniz
11862 FL S
Sağdan Gidiniz
320 x 320 mm

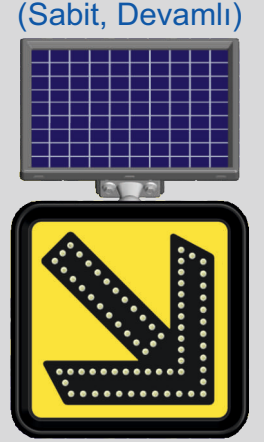

(Sabit, Devamlı)
11864 FL S
Soldan Gidiniz
11866 FL S
Sağdan Gidiniz
320 x 320 mm



Montaj Yüzeyi ve Bağlantı Elemanları



Teknik Özellikler

							Solar Panel	Tip	Glass Laminated
								Ölçü	345 x 293 mm
								Voltaj G.	10 W
								Akım	0.65 A
Ürün Kodu	11850 FL S	11852 FL K	11860 FL S	11862 FL S	11864 FL S	11866 FL S	Batarya	Malzeme	SLA
Ölçü (LxHxW)	400 x 400	400 x 400	400 x 400	400 x 400	400 x 400	400 x 400		Voltaj	12 V
Ağırlık(yaklaşık)	7.6 kg	7.6 kg	7.6 kg	7.6 kg	7.6 kg	7.6 kg		Akım	7.0 A/h
Lens Ölçüsü(Ø)	Ø 300 mm	Ø 300 mm	320 x 320	320 x 320	320 x 320	320 x 320		Renk	Sarı-Kırmızı-Beyaz
Malzeme	PC						LED	Ölçü	Ø 10 mm x78 A
Özellikler	Tek yönlü solar güçle çalışan uyarı flaşörü							Flaş Sayısı	90 f/dk
	Yüksek performanslı reflektif malzeme							Uyarı Mesafesi	500 m gecede
	Güneş paneli topuz şeklindeki metal mafsal sayesinde kendi ekseninde 360° ve öne-arkaya ve sağa-sola 45° yatabilme							Çalışma Süresi	Gün ışığında şarj ile tüm gece
Koruma Sını	Gövde Sızdırmazlık IP 65 Özelliğine Sahip							Çalışma Sıcaklığı	-20 °C / +60 °C
Belgelendirme	DIN EN ISO 9001:2008								
Uygulama	Omega direğe ve Ø50 ile Ø75 mm arası direğe montaj								

Güneş Enerjili Flaşörler



E 107 FL K

GÜNEŞ ENERJİLİ FLAŞÖR

- 360x360mm dış ölçülerindedir
- Ölçü : Ø300mm.
- Gövde : Sac
- Güneş Paneli : 12 V, 10-20W Polikristal
- Batarya : 12 V / 7.18 Ah Şarj edilebilir akü
- Led Sayısı : 103 Adet
- Led Rengi : Sarı / Kırmızı
- Led Parlaklığı : 6000 mcd
- Led Ömrü : 100,000 saat
- Flaş / Dakika : 24 / dk
- Çalışma Süresi : 120 saat
- Çalışma Derecesi : -25 C + 60 C
- Güneş paneli yönlendirme aparatı ile kurulumunda en uygun açığı seçebilme özelliğine sahiptir.



E 106 FL S



E 178 FL K

GÜNEŞ ENERJİLİ FLAŞÖR

- 280X280mm dış ölçülerindedir
- Ölçü : Ø200mm.
- Güneş Paneli : 6 V, 5 W destekli Polikristal
- Batarya : 6 V, 5 Ah Şarj edilebilir akü
- Led Sayısı : 78 Adet
- Led Rengi : Sarı / Kırmızı
- Led Parlaklığı : 6000 mcd
- Led Ömrü : 100,000 saat
- Çalışma Süresi : 120 saat
- Çalışma Derecesi : -25 C + 60 C
- Güneş paneli yönlendirme aparatı ile kurulumunda en uygun açığı seçebilme özelliğine sahiptir.



E 177 FL S

Güneş Enerjili Levhalar

GÜNEŞ ENERJİLİ LEVHALAR

- Ölçü : 600x600x60mm
- Gövde : Eloksallı Alüminyum
- Güneş Paneli : 12V, 10W Polikristal
- Batarya : 12 V / 7 Ah Şarj edilebilir akü
- Led Sayısı : Değişken
- Led Rengi : Sarı / Kırmızı
- Yön : Tek Yönlü
- Flaş / Dakika : 40 / dk
- Çalışma Süresi : 150 - 160 saat
- Çalışma Derecesi: -25 C + 60 C
- Görüş Mesafesi : 500 m



E 158 SL



E 159 SL



E 161 SL



E 108 SL

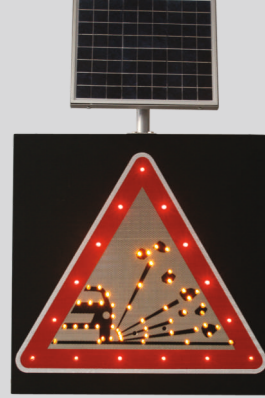

E 109 SL

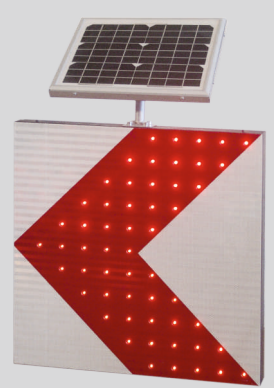

E 110 SL



E 157 SL



E 160 SL



E 111 SL

Güneş Enerjili Levhalar

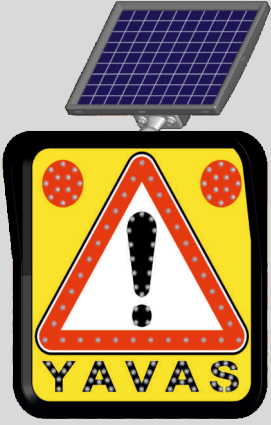

11836 FL
Dikkat



11835 FL
Yolda Çalışma

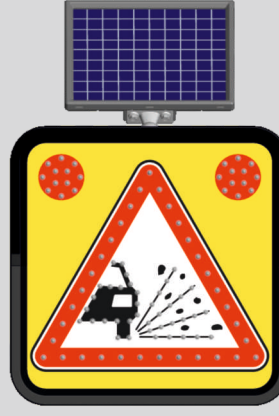

11837 FL
Gevşek Malzemeli Zemin

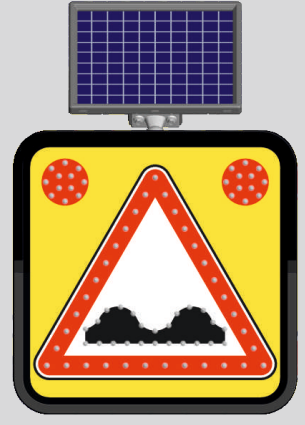

11842 FL
Kasisli Yol

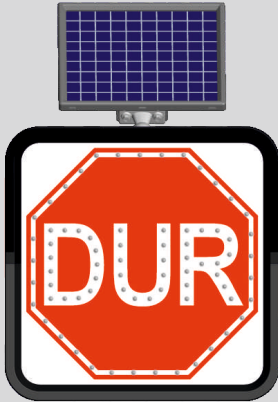

11846 FL
Dur

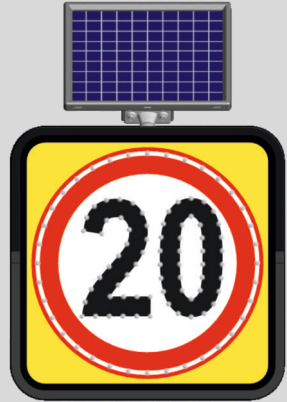

11843 FL
Azami Hız Sınırlaması



11844 FL
Azami Hız Sınırlaması



11845 FL
Azami Hız Sınırlaması

Teknik Özellikler

									Solar Panel	Tip	Glass Laminated
Ürün Kodu	11836 FL	11835 FL	11837 FL	11842 FL	11846 FL	11843 FL	11844 FL	11845 FL		Ölçü	345 x 293 mm
Ölçü (LxHxW)	600 x 600	600 x 600	600 x 600	600 x 600	600 x 600	600 x 600	600 x 600	600 x 600		Voltaj G.	10 W
Ağırlık(yaklaşık)	9.75 kg	9.75 kg	9.75 kg	9.75 kg	9.75 kg	9.75 kg	9.75 kg	9.75 kg		Akım	0.65 A
Malzeme	PC								Batarya	Malzeme	SLA
Özellikler	Tek yönlü solar güçle çalışan uyarı flaşörü									Voltaj	12 V
	Yüksek performanslı reflektif malzeme									Akım	7.0 A/h
	Güneş paneli topuz şeklindeki metal mafsal sayesinde kendi ekseninde 360° ve öne-arkaya ve sağa-sola 45° yatabilme								LED	Renk	Kırmızı-Beyaz
Koruma Sınıfı	Gövde Sızdırmazlık IP 65 Özelliğine Sahip									Ölçü	Ø 5 mm
Belgelendirme	DIN EN ISO 9001:2008									Flaş Sayısı	90 f/dk
Uygulama	Omega direğe ve Ø50 ile Ø75 mm arası direğe montaj									Uyarı Mesafesi	500 m gecede
										Çalışma Süresi	Gün ışığında şarj ile tüm gece
										Çalışma Sıcaklığı	-20°C / +60°C

Güneş Enerjili Levhalar



11832 FL
Soldan Gidiniz



11847 FL
Sağdan Gidiniz

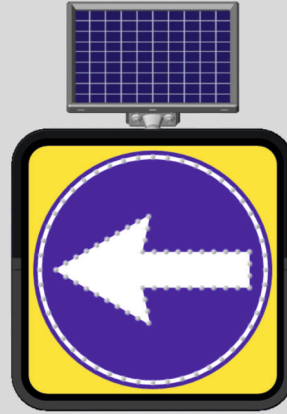

11848 FL
Soldan Gidiniz

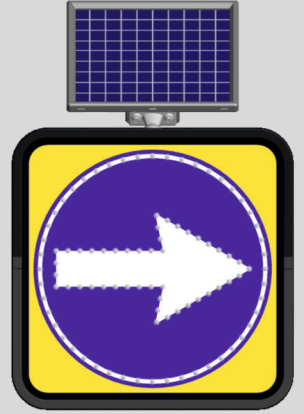

11831 FL
Sağdan Gidiniz



11833 FL
Her İki Yönden Gidiniz

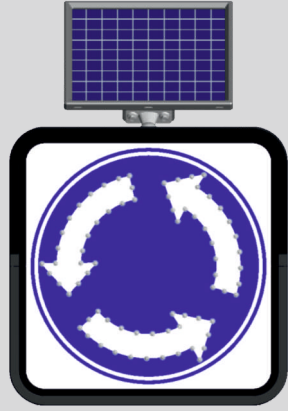

11849 FL
Ada Etrafında Dönünüz

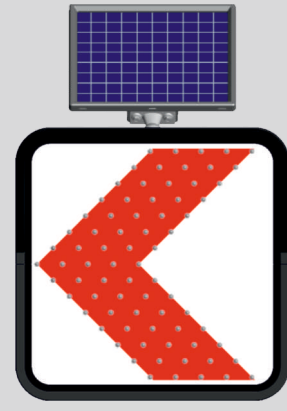

11834 FL
Tehlikeli Viraj Yön Levhası

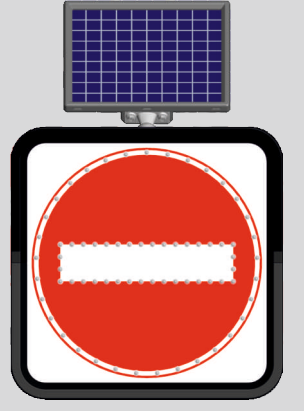

1800-37 FL
Taşıt Giremez Levhası

Teknik Özellikler

									Solar Panel	Tip	Glass Laminated	
Ürün Kodu	11832 FL	11847 FL	11831 FL	11848 FL	11833 FL	11834 FL	11849 FL	1800-37 FL		Ölçü	345 x 293 mm	
Ölçü (HxW)	600 x 600	600 x 600	600 x 600	600 x 600	600 x 600	600 x 600	600 x 600	600 x 600		Voltaj G.	10 W	
Ağırlık(yaklaşık)	9.75 kg	9.75 kg	9.75 kg	9.75 kg	9.75 kg	9.75 kg	9.75 kg	9.75 kg		Akım	0.65 A	
Malzeme	PC										Malzeme	SLA
	Tek yönlü solar güçle çalışan uyarı flaşörü										Voltaj	12 V
	Yüksek performanslı reflektif malzeme										Akım	7.0 A/h
	Güneş paneli topuz şeklindeki metal mafsalları sayesinde kendi ekseninde 360° ve öne-arkaya ve sağa-sola 45°yatabilme										Renk	Beyaz
Koruma Sınıfı	Gövde Sızdırmazlık IP 65 Özelliğine Sahip										Ölçü	Ø 5 mm
Belgelendirme	DIN EN ISO 9001:2008										Flaş Sayısı	90 f/dk
	Omega direğe ve Ø50 ile Ø75 mm arası direğe montaj										Uyarı Mesafesi	500 m gecede
											Çalışma Süresi	Gün ışığında şarj ile tüm gece
											Çalışma Sıcaklığı	-20°C / +60°C

Güneş Enerjili Levhalar

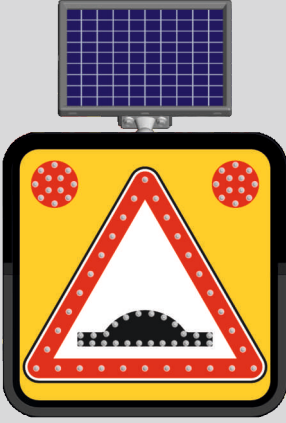

1800-36 FL
Kasisli Yol

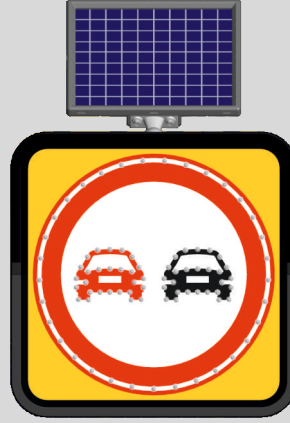

1800-38 FL
Sollama Yasağı

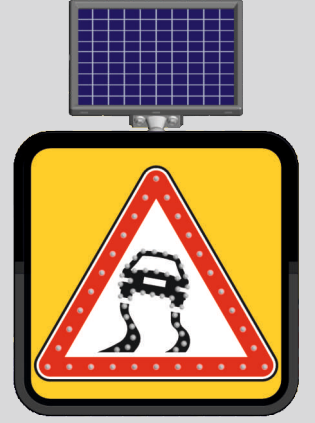

1800-32 FL
Kaygan Yol

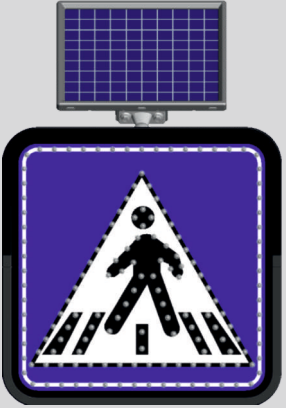

11838 FL
Yaya Geçidi

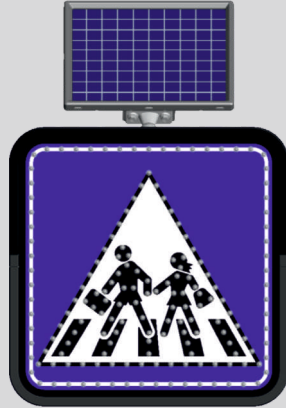

11841 FL
Okul Geçidi

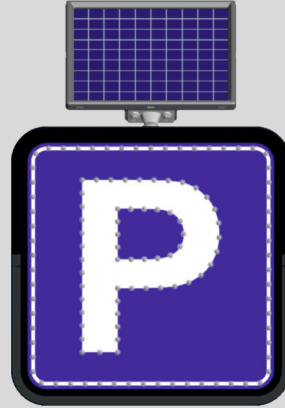

11839 FL
Park Yeri

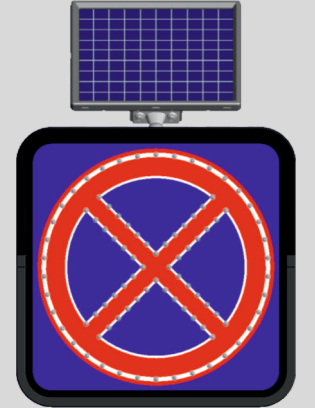

11840 FL
Duraklamak ve Park Etmek Yasaktır

Teknik Özellikler

								Solar Panel	Tip	Glass Laminated
									Ölçü	345 x 293 mm
									Voltaj G.	10 W
									Akım	0.65 A
Ürün Kodu	11800-36FL	11800-38FL	11800-32FL	11838 FL	11841 FL	11839 FL	11840 FL	Batarya	Malzeme	SLA
Ölçü (HxW)	600 x 600	600 x 600	600 x 600	600 x 600	600 x 600	600 x 600	600 x 600		Voltaj	12 V
Ağırlık(yaklaşık)	9.75 kg	9.75 kg	9.75 kg	9.75 kg	9.75 kg	9.75 kg	9.75 kg		Akım	7.0 A/h
Malzeme	PC							LED	Renk	Beyaz
	Tek yönlü solar güçle çalışan uyarı flaşörü								Ölçü	Ø 5 mm
	Yüksek performanslı reflektif malzeme								Flaş Sayısı	90 f/dk
	Güneş paneli topuz şeklindeki metal mafsal sayesinde kendi ekseninde 360° ve öne-arkaya ve sağa-sola 45°yatabilme								Uyarı Mesafesi	500 m gecede
Koruma Sınıfı	Gövde Sızdırmazlık IP 65 Özelliğine Sahip								Çalışma Süresi	Gün ışığında şarj ile tüm gece
Belgelendirme	DIN EN ISO 9001:2008								Çalışma Sıcaklığı	-20°C / +60°C
	Omega direğe ve Ø50 ile Ø75 mm arası direğe montaj									

Güneş Enerjili Levhalar

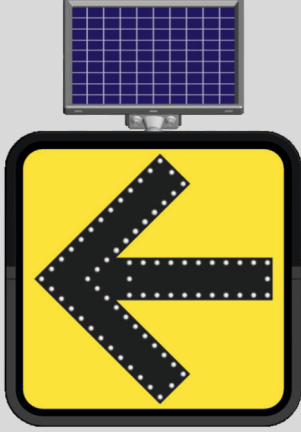

11826 FL
Sola Mecburi Yön

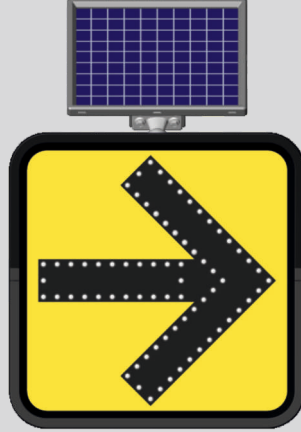

11828 FL
Sağa Mecburi Yön

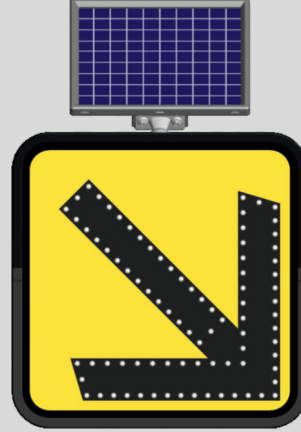

11822 FL
Sağdan Gidiniz

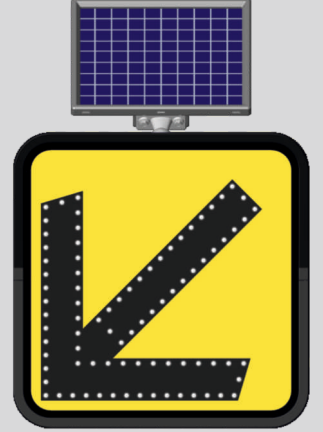

11824 FL
Soldan Gidiniz

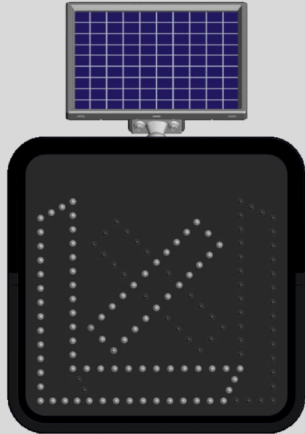

11820 FL
Soldan Gidiniz
Sağ/Sol Yönde Uyarı

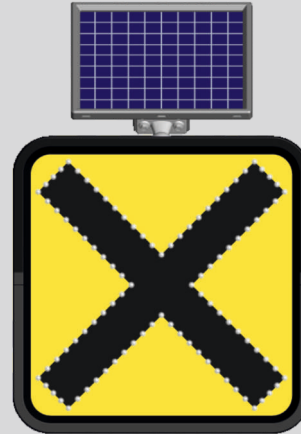

11830 FL
KontROLSÜZ KAVŞAK

Teknik Özellikler

								Tip	Glass Laminated
							Solar Panel	Ölçü	345 x 293 mm
								Voltaj G.	10 W
								Akım	0.65 A
Ürün Kodu	11826 FL	11828 FL	11822 FL	11824 FL	11820 FL	11830 FL	Batarya	Malzeme	SLA
Ölçü (HxW)	600 x 600	600 x 600	600 x 600	600 x 600	600 x 600	600 x 600		Voltaj	12 V
Ağırlık(yaklaşık)	9.75 kg	9.75 kg	9.75 kg	9.75 kg	9.75 kg	9.75 kg		Akım	7.0 A/h
Malzeme	PC						LED	Renk	Sarı
Özellikler	Tek yönlü solar güçle çalışan uyarı flaşörü							Ölçü	Ø5 mm
	Yüksek performanslı reflektif malzeme							Flaş Sayısı	90 f/dk
	Güneş paneli topuz şeklindeki metal mafsal sayesinde kendi ekseninde 360 ° ve öne-arkaya ve sağa-sola 45° yatabilme							Uyarı Mesafesi	500 m gecede
Koruma Sını	Gövde Sızdırmazlık IP 65 Özelliğine Sahip							Çalışma Süresi	Gün ışığında şarj ile tüm gece
Belgelendirme	DIN EN ISO 9001:2008							Çalışma Sıcaklığı	-20°C / +60°C
Uygulama	Omega direğe ve Ø50 ile Ø75 mm arası direğe montaj								

Ledli Bilgi Levhaları



11882 FL-A

Sağdan Gidiniz
(Flaşörlü)
320 x 320 mm



11883 FL-A

Soldan Gidiniz
(Flaşörlü)
320 x 320 mm



11885 FL-A

Flaşörlü Lampa
Ø 300 mm



11880 FL-A

Sağdan Gidiniz
(Sabit, Devamlı)
320 x 320 mm



11881 FL-A

Soldan Gidiniz
(Sabit, Devamlı)
320 x 320 mm



11887 FL-A

Sabit Yanan Lampa
Ø 300 mm

Teknik Özellikler

Ürün Kodu	11882 FL-A	11883 FL-A	11885 FL-A	11880 FL-A	11881 FL-A	11887 FL-A	Çalışma Gerilimi	12 V AC	
Ölçü (HxW)	320 x 320	320 x 320	Ø 300 mm	320 x 320	320 x 320	Ø 300 mm		220 V AC	
Ağırlık(yaklaşık)	3.3 kg	3.3 kg	3.3 kg	3.3 kg	3.3 kg	3.3 kg	LED	Renk	Sarı
Malzeme	PC							Ölçü	Ø 10 mm
Özellikler	Tek yönlü aküyle çalışan uyarı flaşörü							Flaş Sayısı	90 f/dk
	Yüksek performanslı reflektif malzeme							Uyarı Mesafesi	500 m gecede
Koruma Sınıfı	Gövde Sızdırmazlık IP 65 Özelliğine Sahip							Çalışma Süresi	Gün ışığında şarj ile tüm gece
Belgelendirme	DIN EN ISO 9001:2008							Çalışma Sıcaklığı	-20°C / +60°C
Uygulama	Omega direğe ve Ø50 ile Ø75 mm arası direğe montaj								

Ledli Bilgi Levhaları



1 1886 FL A
Dikkat



1 1890 FL A
Yolda Çalışma

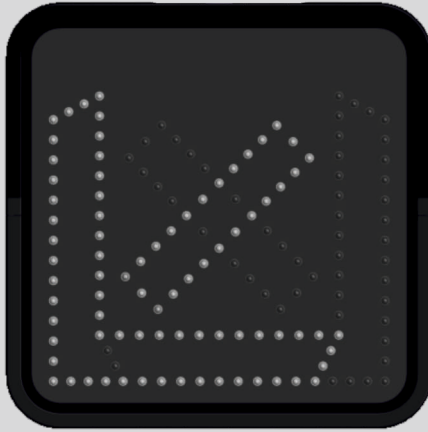

1 1884 FL A
Soldan Gidiniz
Sağ/Sol Yönde Uyarı



1 1888 FL A
Sağdan Gidiniz
1 1889 FL A
Soldan Gidiniz

Teknik Özellikler

								
Ürün Kodu	11886 FL-A	11890 FL-A	11884 FL-A	11888 FL-A	11889 FL-A	Çalışma Gerilimi		
Ölçü (HxW)	600 x 600	600 x 600	600 x 600	600 x 600	600 x 600		12 V AC	
Ağırlık(yaklaşık)	5.5 kg	5.5 kg	5.5 kg	5.5 kg	5.5 kg	220 V AC		
Malzeme	PC					LED		
Özellikler	Tek yönlü aküyle çalışan uyarı flaşörü						Renk	Sarı-Kırmızı-Beyaz
	Yüksek performanslı reflektif malzeme						Ölçü	Ø5 mm
Koruma Sını	Gövde Sızdırmazlık IP 65 Özelliğine Sahip						Flaş Sayısı	90 f/dk
Belgelendirme	DIN EN ISO 9001:2008						Uyarı Mesafesi	500 m gecede
Uygulama	Omega direğe ve Ø50 ile Ø75 mm arası direğe montaj						Çalışma Süresi	Gün ışığında şarj ile tüm gece
							Çalışma Sıcaklığı	-20°C / +60°C

Ürün Uygulama ve Aksesuarları

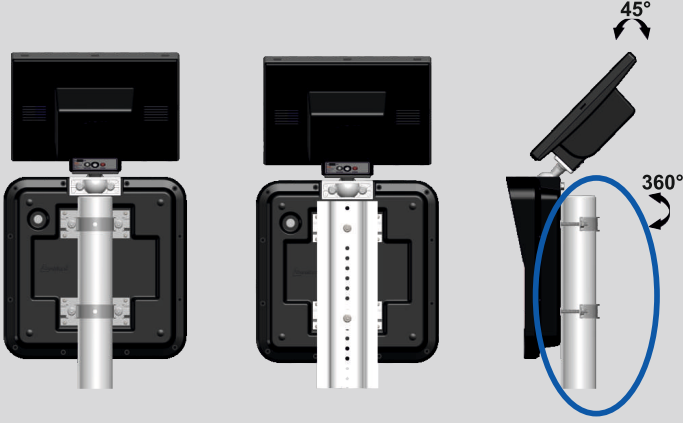

Solar Ledli Bilgi Levhaları, özel tasarlanmış kelepçe ile omega ve $\text{Ø}50$ ile $\text{Ø}75$ mm boru direklere kolayca montajlanır, montaj kelepçesi sayesinde yukarı aşağı hareketi ayarlanır.

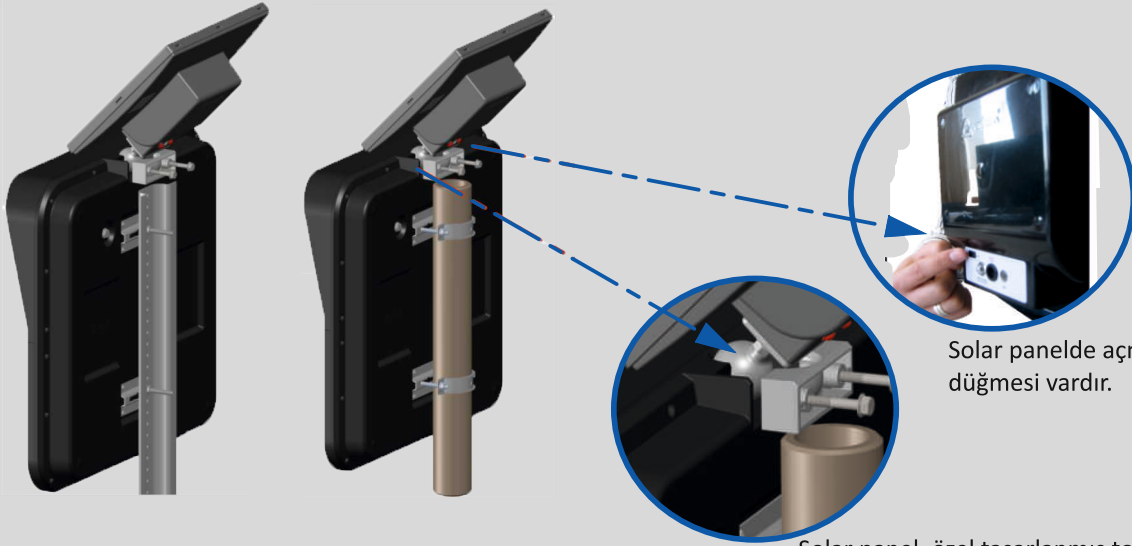

Solar panelde açma-kapama düğmesi vardır.

Solar panel, özel tasarlanmış topuz şeklindeki metal mafsalla kendi ekseninde 360° , öne-arkaya ve sağa-sola 45° hareket kabiliyetine sahiptir.



Levhanın üst kısmında açma-kapama düğmesi vardır.



Akülü Ledli Bilgi Levhaları, özel tasarlanmış kelepçe ile omega ve $\text{Ø}50$ ile $\text{Ø}70$ mm boru direklere kolayca montajlanır, montaj kelepçesi sayesinde yukarı aşağı hareketi ayarlanır.

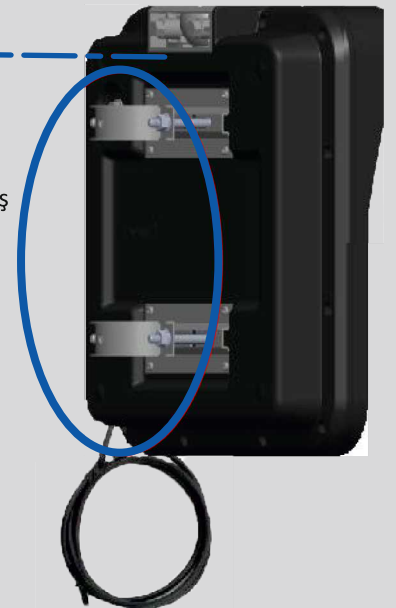

Güneş Enerjili Yol Bakım Levhaları

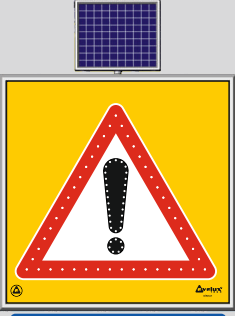

11764 SLD



11730 SLD

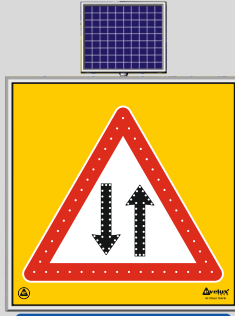

11762 SLD

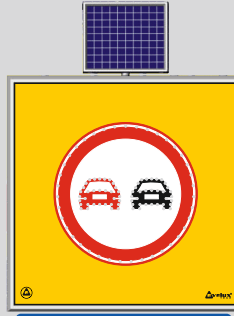

11766 SLD

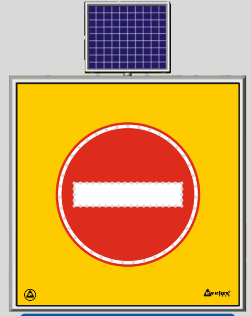

11768 SLD

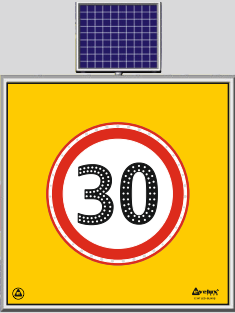

11738 SLD



11736 SLD

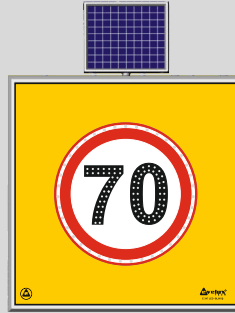

11734 SLD

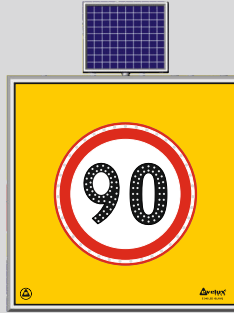

11732 SLD

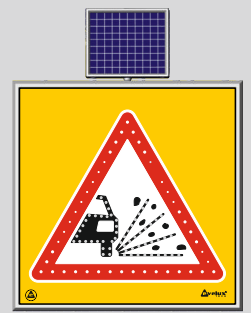

11777 SLD

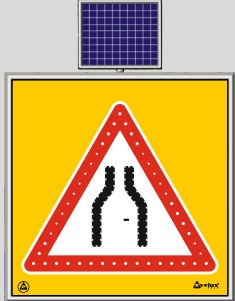

11774 SLD

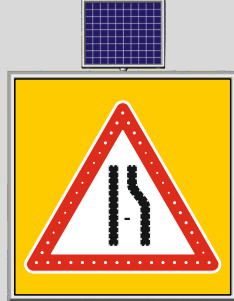

11775 SLD

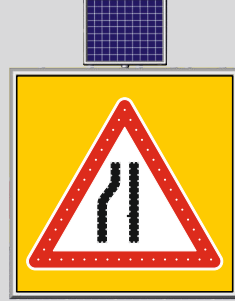

11776 SLD

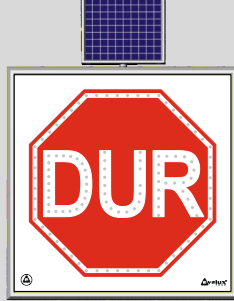

11778 SLD

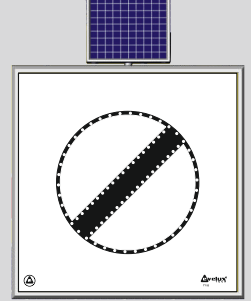

11749 SLD

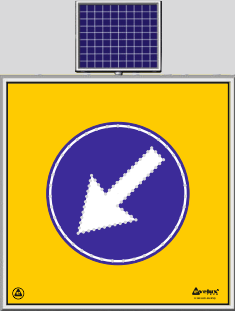

11740 SLD

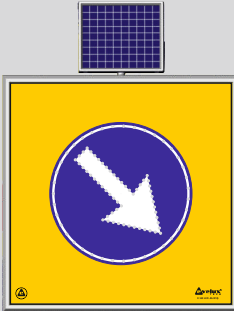

11742 SLD

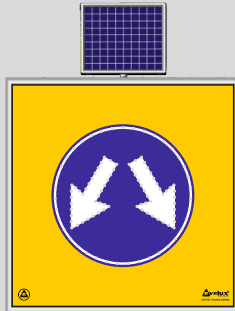

11744 SLD

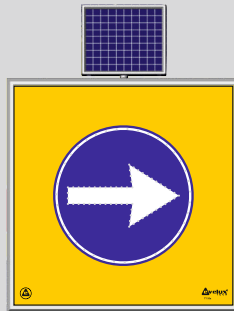

11748 SLD

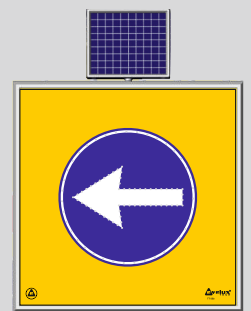

11746 SLD

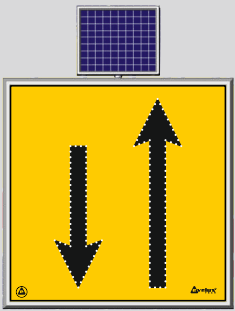

11773 SLD

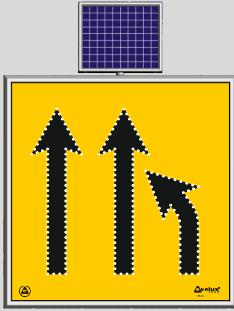

11779 SLD

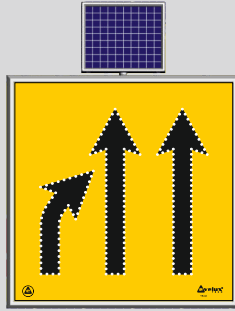

11780 SLD

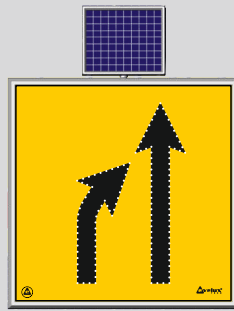

11770 SLD

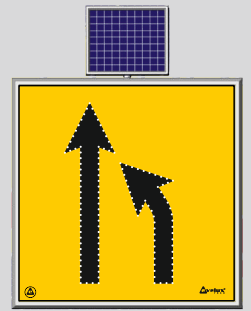

11772 SLD

Güneş Enerjili Yol Bakım Levhaları

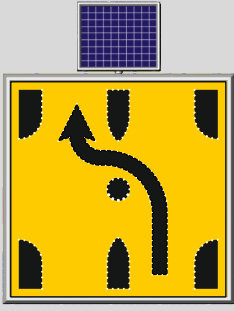

11724 SLD

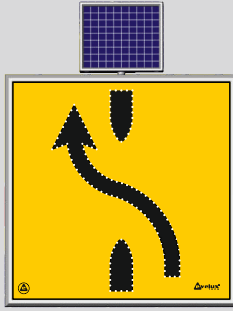

11720 SLD

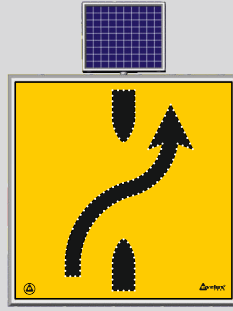

11722 SLD



11710 SLD



11712 SLD

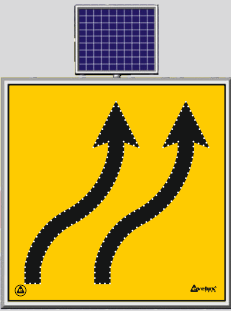

11725 SLD

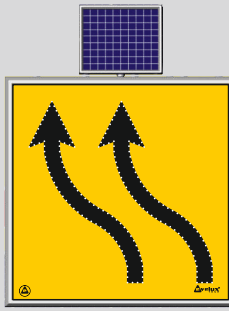

11727 SLD

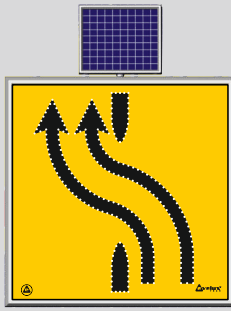

11726 SLD

Elektronik Devre Teknik Özellikler

Solar Panel	Tip	Glass Laminated
	Ölçü	345x293 mm
	Voltaj	10 V
	Akım	0.65 A
	Malzeme	SLA
Batarya/LED	Voltaj	12 V
	Akım	7.0 A/h
	Renk	Kırmızı-Beyaz
	Ölçü	Ø5 mm
	Flaş Sayısı	54 f/dk
F.Uyarı Mesafesi	500 m (gece)	
Çalışma Süresi	Gün ışığında şarj ile tüm gece	
Çalışma Sıcaklığı	-20°C/+60°C	



11716 SLD

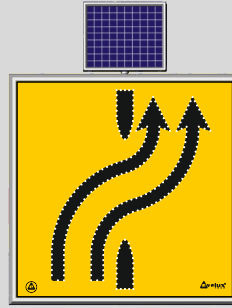

11728 SLD

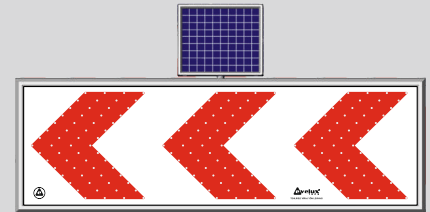

11750 SLD

Ürün Teknik Özellikler

Kod	11710 S-LD	11712 S-LD	11750 S-LD	11716 S-LD
Ölçü(UxG)	1000x2000 mm	1000x2000 mm	500x1500 mm	1000x1750 mm
Ağırlık(yaklaşık)	30.00 kg	30.00 kg	19.00 kg	28.00 kg
Malzeme (göde-zemin)	AL-Reflektif	AL-Reflektif	AL-Reflektif	AL-Reflektif

Ürün Teknik Özellikler

Kod	11720 S-LD	11722 S-LD	11724 S-LD	11725 S-LD	11726 S-LD	11727 S-LD	11728 S-LD	11730 S-LD
	11732 S-LD	11734 S-LD	11736 S-LD	11738 S-LD	11740 S-LD	11742 S-LD	11744 S-LD	11746 S-LD
	11748 S-LD	11749 S-LD	11762 S-LD	11764 S-LD	11766 S-LD	11768 S-LD	11770 S-LD	11772 S-LD
	11773 S-LD	11774 S-LD	11775 S-LD	11776 S-LD	11777 S-LD	11778 S-LD	11779 S-LD	11780 S-LD
Ölçü(UxG)	1000x1000 mm	1000x1000 mm	1000x1000 mm	1000x1000 mm	1000x1000 mm	1000x1000 mm	1000x1000 mm	1000x1000 mm
Ağırlık(yaklaşık)	19.00 kg	19.00 kg	19.00 kg	19.00 kg	19.00 kg	19.00 kg	19.00 kg	19.00 kg
Malzeme (göde-zemin)	AL-Reflektif	AL-Reflektif	AL-Reflektif	AL-Reflektif	AL-Reflektif	AL-Reflektif	AL-Reflektif	AL-Reflektif

Dubalı Uyarı Dikmeleri



12418 DB

12420 DBR

12422 DBR

12402 DB

12404 DBR

12414 DBR









12401-1 DB

12403-1 DBR

12409-1 DBR

Teknik Özellikler

									
Ürün Kodu	12418 DB	12420 DB R	12422 DB R	12402 DB	12404 DB R	12414 DB R	12401-1 DB	12403-1 DBR	12409-1 DBR
Ölçü (ØxH)	80 x 1100	80 x 1100	80 x 1100	110 x 1200	110 x 1200	110 x 1200	63 x 1000	63 x 1000	63 x 1000
Ağırlık(yaklaşık)	6.5 kg	6.5 kg	6.5 kg	12.0 kg	12.0 kg	12.0 kg	4.0 kg	4.0 kg	4.0 kg
Malzeme	PP- PVC Compound			PPC-PP Taban			PP- PVC Compound		
	-	Reflektif Bant		-	Reflektif Bant		-	Reflektif Bant	
	Esnek Ağırlık Taban			Mozaik Dolgu Ağırlık Taban			Esnek Ağırlık Taban		
Özellikler	Taşıma kancası ve ilave soket ile kolay demontaj								
	Levha tutucu ve zincir								
	Kolay demontaj - Geçmeli ve kilitlemeli ağırlık sistemi - Rüzgar direnci								
Belgelendirme	DIN EN ISO 9001:2008								
Uygulama	Evelux lamba, levha ve diğer aksesuarlar								

Dubalı Uyarı Levhalı Bariyerler

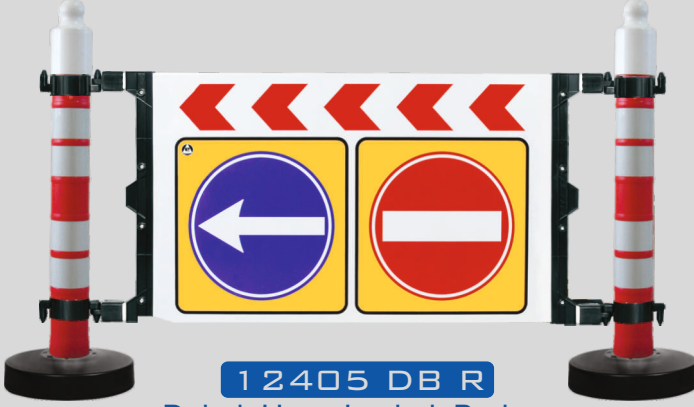

12405 DB R
Dubalı Uyarı Levhalı Bariyer



ŞEKİL 1

ŞEKİL 2



ŞEKİL 3

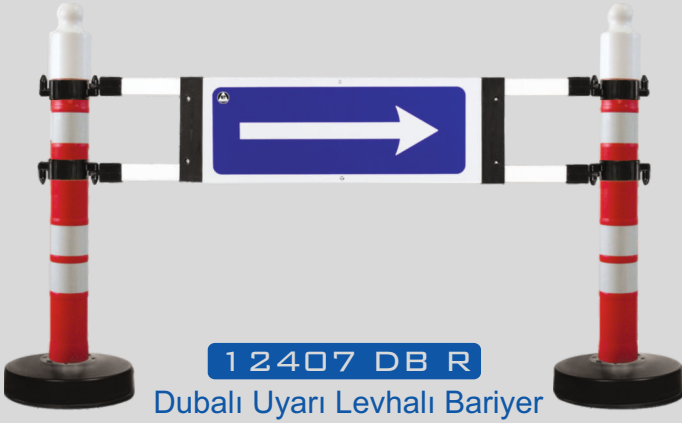

12407 DB R
Dubalı Uyarı Levhalı Bariyer



ŞEKİL 1

ŞEKİL 2

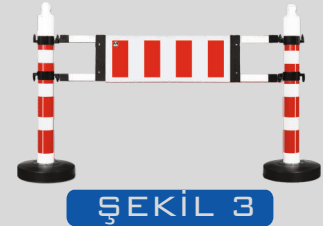

ŞEKİL 3

Teknik Özellikler

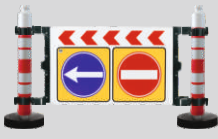
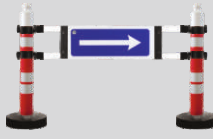
		
Ürün Kodu	12405 DB R	12407 DB R
Ölçü (WxH)	1800 x 1200	1800 x 1200
Ağırlık(yaklaşık)	31.0 kg	27.0 kg
Malzeme	PPC Dikme-PVC Levha Reflektif ASTM D4956-11a	
Özellikler	Taşıma kancası ve ilave soket ile kolay demontaj	
	Mozaik dolgu ağırlık taban	
	Farklı levha uygulamaları	
	Evelux lamba, levha ve diğer aksesuarlar	
Belgelendirme	DIN EN ISO 9001:2008	
Uygulama	Evelux kelepçesi dikmeler üzerine monte edilir, levha tutucular ile birlikte kelepçelere geçirilir	

Katlanır Uyarı Levhalı Bariyer



Katlanır Uyarı Levhalı Bariyer



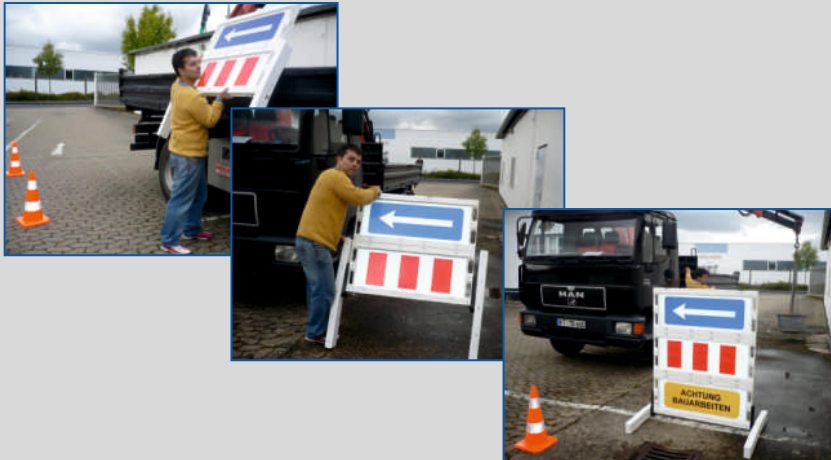

Katlanır Uyarı Levhalı Bariyer

Ok Kullanım Yönüne Göre Değiştirilebilir.



Teknik Özellikler

		
Ürün Kodu	12500 FB R	12501 FB R
Ölçü (WxH)	900 x 1500	1000 x 910
Ağırlık(yaklaşık)	18.0 kg	20.0 kg
Malzeme	PPC Tutucu - PVC Levha	
Özellikler	Reflektif Folyo Levhalı ASTM D 4956-11a	
	İlave soket-Taşıma yuvaları	
	Evelux lamba, levha ve diğer aksesuarlar	
	Farklı levha uygulamaları	
Belgelendirme	DIN EN ISO 9001:2008	
Uygulama	Evelux panel bariyerlere tutturulur	

Katlanır Uyarı Levhalı Bariyer



12503 FB R

Katlanır Uyarı Levhalı
Bariyer



ŞEKİL 1



ŞEKİL 2

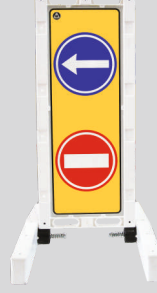

ŞEKİL 3

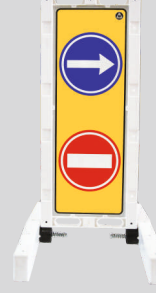

ŞEKİL 4



ŞEKİL 5

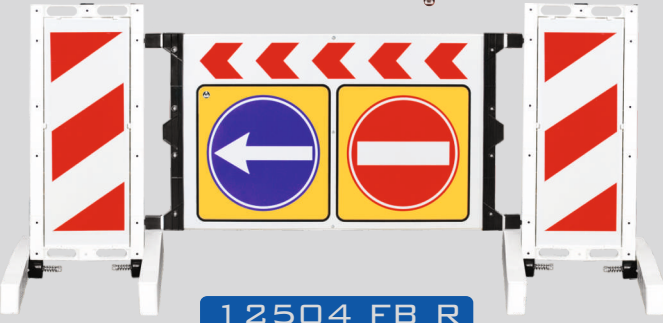

12504 FB R

Katlanır Uyarı Levhalı Bariyer



ŞEKİL 1



ŞEKİL 2



ŞEKİL 3

Teknik Özellikler

		
Ürün Kodu	12503 FB R	12504 FB R
Ölçü (WxH)	420 x 1100	2360 x 1100
Ağırlık(yaklaşık)	15.5 kg	37.0 kg
Malzeme	PPC Tutucu-PVC Levha	
Özellikler	Reflektif Folyo Levhalı ASTM D 4956-11a	
	İlave Soket-Taşıma Yuvaları	
	Evelux lamba, levha ve diğer aksesuarlar	
	Farklı levha uygulamaları	
Belgelendirme	DIN EN ISO 9001:2008	
Uygulama	Evelux panel bariyerlere tutturulur.	

Katlanır Uyarı Levhalı Bariyer

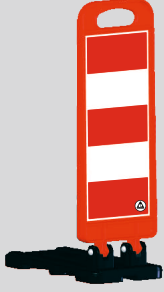

12416 DB R

Katlanır Uyarı Levhası

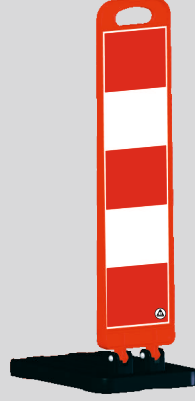

12415 DB R

Katlanır Uyarı Levhası

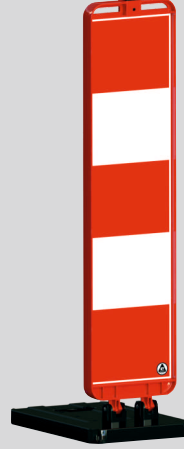

12410 DB R

Katlanır Uyarı Levhası



ŞEKİL 1



ŞEKİL 2



ŞEKİL 3



ŞEKİL 4



ŞEKİL 5



12417 DB R

Katlanır Uyarı Levhası



ŞEKİL 1



ŞEKİL 2



ŞEKİL 3



ŞEKİL 4



ŞEKİL 5



ŞEKİL 6



ŞEKİL 7



ŞEKİL 8



ŞEKİL 9



ŞEKİL 10



12413 DB R

Esnek Uyarı Levhası

Teknik Özellikler

Ürün Kodu	12417 DB R	12413 DB R	12416 DB R	12415 DB R	12410 DB R
Ölçü (LxWxH)	480x600x900	340x100x800	450x200x700	480x200x1000	480x250x1200
Ağırlık(yaklaşık)	12.0 kg	4.5 kg	6.5 kg	11.1 kg	12 kg
Malzeme	PPC Levha	TPU Levha	PPC-PVC/St		
Reflektif	ASTM D 4956-11a	EN 13422			
Özellikler	Ağırlık PVC Taban				
	Katlanabilir	Esnek Kırılmaz	Katlanabilir-Taşıma Kancası		
	Tek Yönlü Uyarı	İki Yönlü Uyarı			
Belgelendirme	Farklı Baskı Seçenekleri				
Uygulama	DIN EN ISO 9001:2008				
	Kullanıma Hazır				

Levhalı ve Portatif Dubalar



12425 DB R A
Ultra Levhalı Duba
(İki Yönde Uyarı)



12423 DB R A
Ultra Levhalı Duba
(Tek Yönde Uyarı)



ŞEKİL 1



ŞEKİL 2



ŞEKİL 3



12424 DB R A
Ultra Reklam Dubası
(İki Yönde Uyarı)



12426 DB R A
Ultra Reklam Dubası
(İki Yönde Uyarı)



107 A
Portatif Uyarı ve
Reklam Levhası



108 A F
Portatif Uyarı ve
Reklam Levhası

Teknik Özellikler

Ürün Kodu	12425DBR A	12423DBR A	12424DBR A	12426DBR A	107 A	108 A F
Ölçü (LxWxH)	495x395x905 mm	495x395x905 mm	495x395x905 mm	495x395x905 mm	245x620	245x620
Ağırlık(yaklaşık)	7 kg	7 kg	7 kg	7 kg	1.35 kg	1.35 kg
Malzeme	PPC Gövde - PVC Taban				ABS	
Özellikler	Yan yüzeylerde zincir geçirme kanalı Yivli, lamba/levha takma yuvası Normalperformanslı reflektif yüzey				Katlanır Gövde Reflektif Mercek	
Belgelendirme	Reflektif :ASTM D 4956-11a Tip I					

Güvenlik Barikadı



12510 FB R
Güvenlik Barikadı
(WxH) 1500 x 1000 mm



12512 FB R
Levhali Barikat
(Sağ - Sol)
(WxH) 1500 x 1000 mm

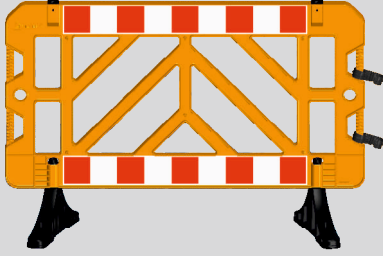

ŞEKİL 1

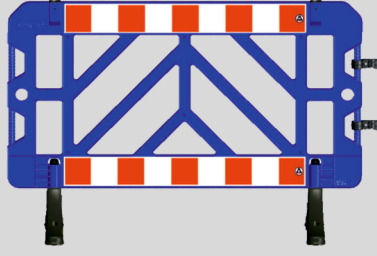

ŞEKİL 2

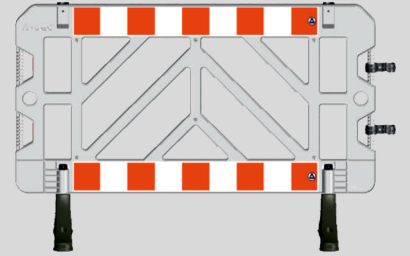

ŞEKİL 3

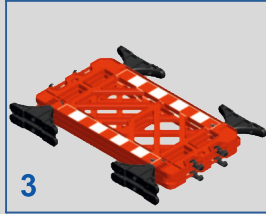
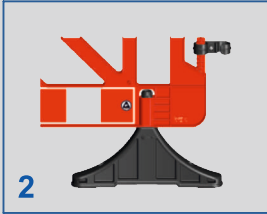
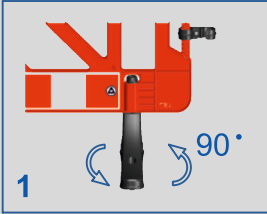

Ayaklar 90° çevrilerek taşıma kolaylığı ve istifleme avantajı sağlar.

Teknik Özellikler

		
Ürün Kodu	12510 FB R	12512 FB R
Ölçü (WxH)	1500 x 1000	1500 x 1000
Ağırlık(yaklaşık)	12.3 kg	12.3 kg
Malzeme	PPC Gövde - PVC Ayak	
Özellikler	-	Farklı levha uygulamaları
	Reflektif yapıştırma yüzeyi	
	Kelepçe ile birbirine ilave edilebilme	
	Evelux lamba ve levha uygulamaları	
Belgelendirme	DIN EN ISO 9001:2008	
Uygulama	Geniş tabanları ile zeminde durabilme ve vida dübel ile de zemine uygulama	



Güvenlik Bariyeri

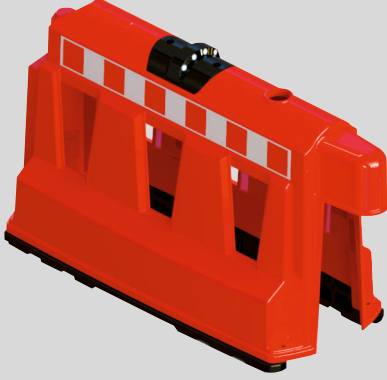

12520 FB R
Güvenlik Bariyeri
Kırmızı



ŞEKİL 1



ŞEKİL 2

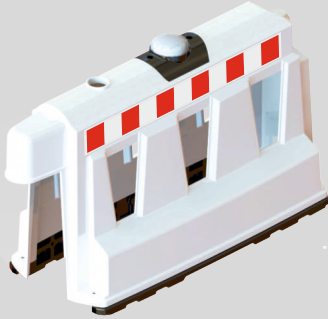

12526 FB R
Güvenlik Bariyeri
Beyaz



12524 FB R
Güvenlik Bariyeri
Sarı



12522 FB R
Güvenlik Bariyeri
Kırmızı

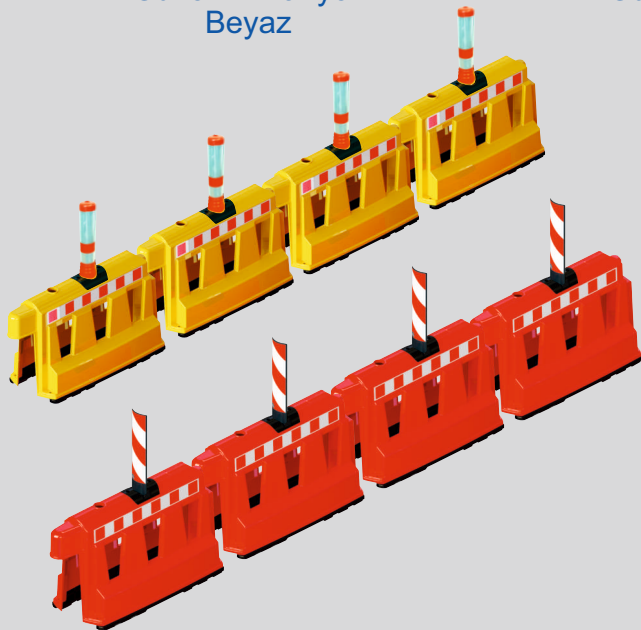

Teknik Özellikler

				
Ürün Kodu	12520 FB R	12522 FB R	12524 FB R	12526 FB R
Ölçü (LxWxH)	400x1000x600	400x1000x600	400x1000x600	400x1000x600
Ağırlık(yaklaşık)	20 kg	20 kg	20 kg	20 kg
Malzeme	PPC - PVC			
Reflektif	ASTM D 4956-11a Tip I EN 13422 / Class R2B			
Özellikler	Ağırlıklı taban ile devrilmeye karşı güçlü mukavemet Birbirine geçmeli birleştirme özelliği İsteğe bağlı zemine sabitleme imkanı			Flaşörlü
Belgelendirme	DIN EN ISO 9001:2008			
Uygulama	Seyyar veya Sabit Kullanım (18xØ90x10 mm vidalı dübel) 4 adet			

PVC Trafik Konileri



12321TK
(h)900 mm



12325TKR2
(h)900 mm



12327TKAR2
(h)900 mm



12329TK
(h)900 mm



12331TKR2
(h)900 mm



12305TK
(h)750 mm



12307TKR1
(h)750 mm



12309TKR2
(h)750 mm



12315TKAR2
(h)750 mm



12333TK
(h)700 mm



12335TKR1
(h)700 mm



12337TKR2
(h)700 mm



12328TK
(h)520 mm



12330TKR1
(h)520 mm



12332TKR2
(h)520 mm



12314TK
(h)500 mm



12316TKR2
(h)500 mm



12317TK
(h)500 mm



12318TKR1
(h)500 mm



12304TK
(h)500 mm



12306TKR1
(h)500 mm



12326TKAR1
(h)500 mm



12303TKR1
(h)320 mm

PPC Trafik Konileri



1 2300 TK
(h)500 mm



1 2301 TKA
(h)520 mm



1 2350 TK
(h)600 mm



1 2351 TKA
(h)613 mm



1 2352 TKA
(h)613 mm



1 2302 TK
(h)500 mm



1 2322 TKR2
(h)750 mm



1 2320 TKA R2
(h)750 mm

Teknik Özellikler PVC Trafik Konileri

Ürün Kodu	12321 TK	12325 TK R2	12327 TKAR2	12329 TK	12331 TKR2	12305 TK	12307 TKR1	12309 TK R2	12315 TKAR2	12333 TK	12335 TKR1	12337 TKR2
Ölçü (AxH)	385 x 900	385 x 900	485 x 900	385 x 900	385 x 900	385 x 750	385 x 750	385 x 750	485 x 750	380 x 700	380 x 700	380 x 700
Ağırlık(yaklaşık)	3.6 kg	3.6 kg	6.9 kg	4.0 kg	4.0 kg	3.2 kg	3.2 kg	3.2 kg	6.5 kg	2.3 kg	2.3 kg	2.3 kg
Malzeme	PVC											

Teknik Özellikler PVC Trafik Konileri

Ürün Kodu	12328 TK	12330 TK R1	12332 TK R2	12304 TK	12306 TKR1	12326 TKAR1	12317 TK	12318 TKR1	12314 TK	12316 TK R2	12303 TK R1
Ölçü (AxH)	320 x 520	320 x 520	320 x 520	285 x 500	285 x 500	385 x 500	350 x 500	350 x 500	350 x 500	350 x 500	220 x 320
Ağırlık(yaklaşık)	1.25 kg	1.25 kg	1.25 kg	1.3 kg	1.3 kg	2.65 kg	1.80 kg	1.80 kg	1.7 kg	1.7 kg	0.650 kg
Malzeme	PVC										

Teknik Özellikler PPC Trafik Konileri

Ürün Kodu	12300 TK	12301 TK A	12350 TK	12351 TK A	12352 TK A	12302 TK	12322 TK R2	12320 TK A R2
Ölçü (AxH)	350 x 500	350 x 520	370 x 600	370 x 613	370 x 613	350 x 500	400 x 750	460 x 750
Ağırlık(yaklaşık)	1.15 kg	4.0 kg	1.5 kg	5.15 kg	5.15 kg	0.850 kg	2.2 kg	4.9 kg
Malzeme	PPC							

Esnek Refüj Başı Levhaları



12250 UB R

Esnek Refüj Başı Levhası



12254 UB R

Esnek Refüj Başı Levhası



12253 UB R

Esnek Refüj Başı Levhası

"Siparişte Yön Belirtiniz."



12256 UB R

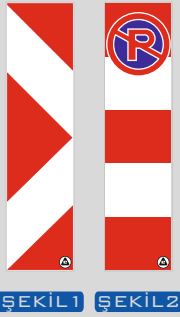

ŞEKİL 1 ŞEKİL 2



12258 UB R



ŞEKİL 1 ŞEKİL 2



Teknik Özellikler					
Ürün Kodu	12250 UB R	12254 UB R	12253 UB R	12256 UB R	12258 UB R
Ölçü (LxH)	300 x 1000	200 x 900	100 x 800	(H)800	(H)500
Ağırlık(yaklaşık)	3.25 kg	2.0 kg	1.4 kg	1.4 kg	0.950 kg
Malzeme	TPU - Polyurethane				
	Reflektif Folyo				
	Kırılmaz				
Özellikler	Körük Sistemi-Esnek Tasarım				
	Eğilme ve bükülmelere karşı dayanıklı mikroprizmatik reflektif malzeme				
	UV katkıli parlak siyah renk		UV katkıli parlak turuncu renk		
Belgelendirme	TS EN 13422+A1				
Uygulama	Ø18 x L 90 x Ø10 mm vida dübel ile zemine uygulama				

Şerit Ayırıcı Esnek Delineatorlar



12211 UB R
(100 cm) Delineator



12288 UB R
(100 cm) Delineator



12221 UB R
(100 cm) Delineator



12241 UB R
(100 cm) Delineator



12212 UB R
(75 cm) Delineator



12286 UB R
(75 cm) Delineator



12222 UB R
(75 cm) Delineator



12242 UB R
(75 cm) Delineator



12214 UB R
(45 cm) Delineator



12284 UB R
(45 cm) Delineator



12224 UB R
(45 cm) Delineator



12244 UB R
(45 cm) Delineator



12215 UB R
(30 cm) Delineator



12282 UB R
(30 cm) Delineator



12225 UB R
(30 cm) Delineator





12245 UB R
(30 cm) Delineator

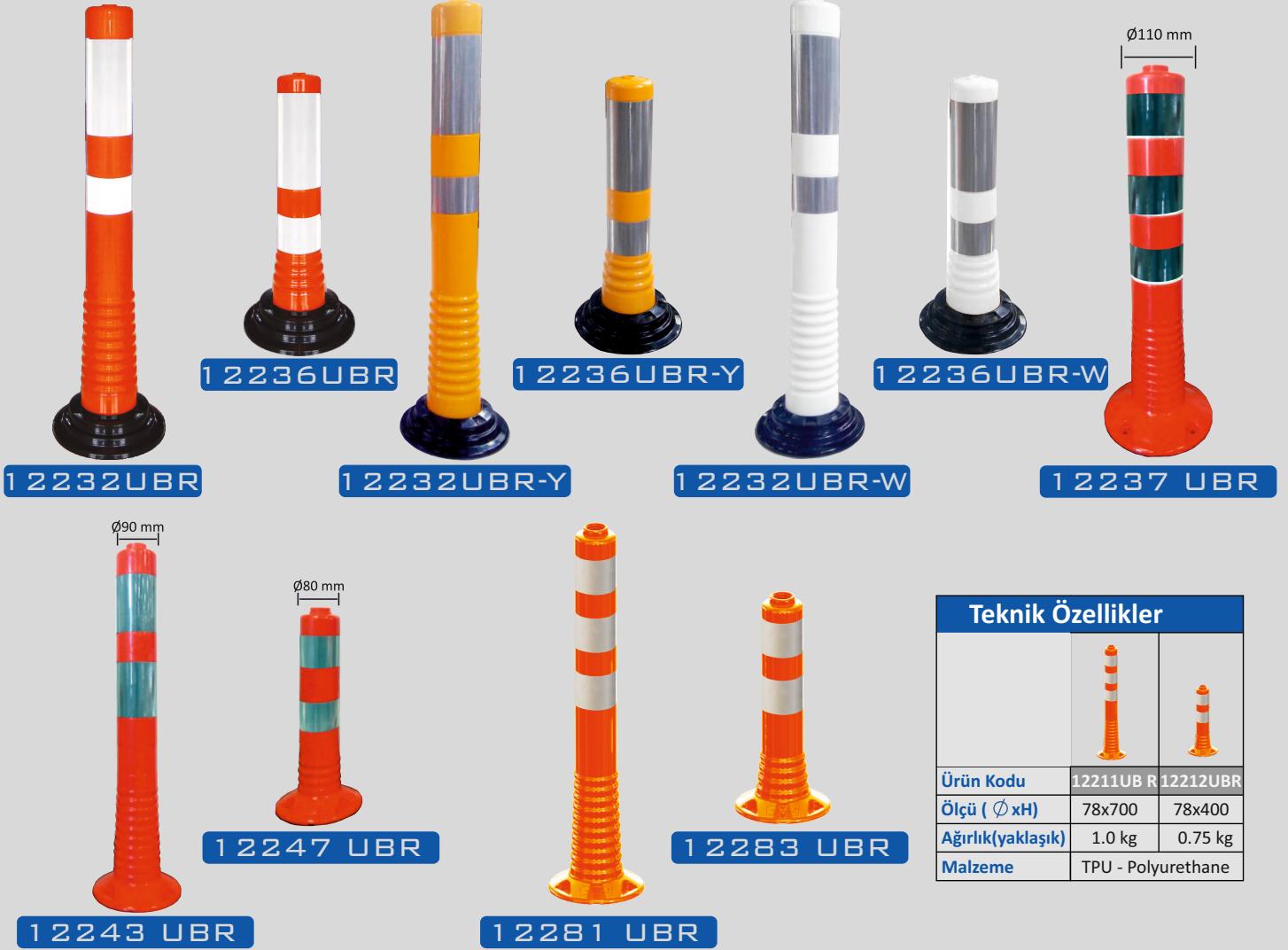











Şerit Ayırıcı Esnek Delineatorlar















Teknik Özellikler

		
Ürün Kodu	12211UB R	12212UBR
Ölçü (Ø xH)	78x700	78x400
Ağırlık(yaklaşık)	1.0 kg	0.75 kg
Malzeme	TPU - Polyurethane	

Teknik Özellikler

													
Ürün Kodu	12211UB R	12212UBR	12214UBR	12215UBR	12288UBR	12286UBR	12284UBR	12282UBR	12241UBR	12242UBR	12244UBR	12245UBR	12237UBR
Ölçü (Ø xH)	80x1000	80x750	80x450	80 x 300	80x1000	80x750	80x450	80x300	80x1000	80x750	80x450	80x300	110x750
Ağırlık(yaklaşık)	1.6 kg	1.2 kg	0.980 kg	0.720 kg	1.6 kg	1.2 kg	0.980 kg	0.720 kg	1.6 kg	1.2 kg	0.980 kg	0.720 kg	2.10 kg
Malzeme	TPU - Polyurethane												

Teknik Özellikler

												
Ürün Kodu	12221UB R	12222UBR	12224UBR	12225UBR	12236UBR	12232UBR	12236UBR-Y	12232UBR-Y	12236UBR-W	12232UBR-W	12243UBR	12247UBR
Ölçü (Ø xH)	80x1000	80x750	80x450	80 x 300	80x450	80x750	80x450	80x750	80x450	80x750	90x750	80x500
Ağırlık(yaklaşık)	1.6 kg	1.2 kg	0.980 kg	0.720 kg	1.1 kg	1.48 kg	1.1 kg	1.48 kg	1.1 kg	1.48 kg	1.5 kg	1.0 kg
Malzeme	TPU - Polyurethane											

Refüj Dubaları



12205 UB R
Refüj Ayırıcı Duba



ŞEKİL 1



ŞEKİL 2



12213 UB R
Refüj Dubası



ŞEKİL 1



ŞEKİL 2



12223 UB R
Refüj Dubası



ŞEKİL 1

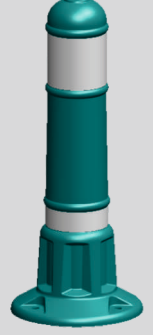

ŞEKİL 2

Teknik Özellikler

Ürün Kodu	12205 UB R	12223 UB R	12213 UB R
Ölçü (Ø xH)	270 x 500	200 x 500	200 x 800
Ağırlık(yaklaşık)	1.48 kg	0.890 kg	1.24 kg
Malzeme	PE	PPC	
Özellikler	Reflektif malzeme		
	Dairesel uyarı		
	Siyah, mavi, yeşil ve kırmızı renk seçeneği		
Belgelendirme	DIN EN ISO 9001:2008		
Uygulama	Ø18xL90x Ø10 mm vida dübel ile		

Delineatorlü Şerit Düzenleme Butonları



12268 UB R
Delineatorlü Şerit
Düzenleme Butonu



12270 UB R
Delineatorlü Şerit
Düzenleme Butonu



12203 UB R
Uyarı Levhalı Şerit
Düzenleme Butonu



12206 UB R
Ayırma Butonu
Uyarı Levhalı Şerit



12219 UB R
Delineatorlü Şerit
Düzenleme Butonu



12218 UB R
Delineatorlü Şerit
Düzenleme Butonu



12266 UB R
Uyarı Levhalı Şerit
Düzenleme Butonu



12204 UB R
Uyarı Levhalı Şerit
Düzenleme Butonu



12207 UB R
Uyarı Levhalı Şerit
Ayırma Butonu

Teknik Özellikler

Ürün Kodu	12270 UB R	12268 UB R	12218 UB R	12219 UB R	12266 UB R	12203 UB R	12207 UB R	12204 UB R	12206 UB R
Ölçü (Ø xH)	1000x220x455	1000x220x755	1000x200x455	1000x200x755	1000x220x650	1200x150x280	260x160x280	1200x150x600	260x160x600
Ağırlık(yaklaşık)	4.0 kg	4.3 kg	4.15 kg	4.5 kg	3.75 kg	2.5 kg	0.750 kg	2.7 kg	0.900 kg
Malzeme	PPC Taban - TPU Delineator				PPC Taban-PE Levha				

Şerit Sınırlama Butonları

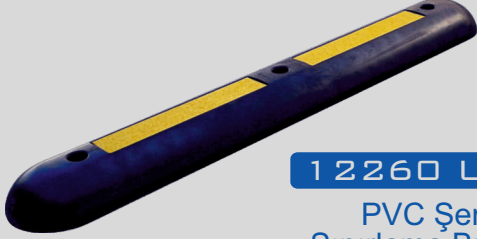

12260 UB R

PVC Şerit Sınırlama Butonu

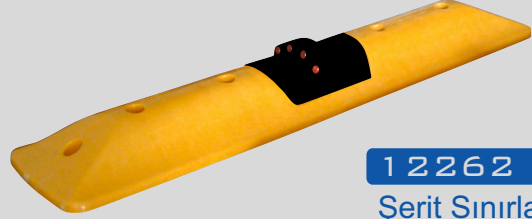

12262 UB

Şerit Sınırlama Butonu

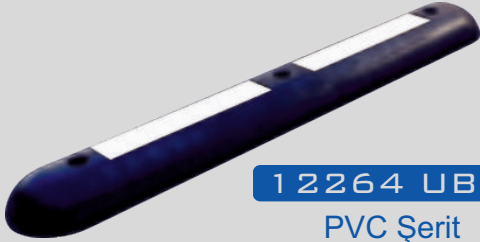

12264 UB R

PVC Şerit Sınırlama Butonu



12217 UB

Şerit Sınırlama Butonu



12202 UB

Şerit Sınırlama Butonu

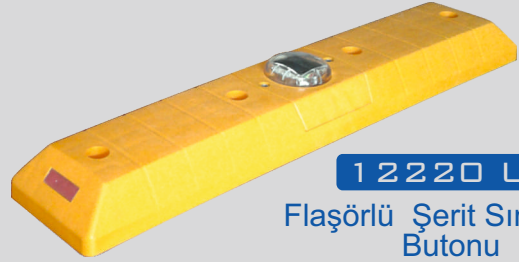

12220 UB

Flaşörlü Şerit Sınırlama Butonu



12263 UB

Şerit Sınırlama Butonu



12261 UB

Flaşörlü Şerit Sınırlama Butonu

Teknik Özellikler

Ürün Kodu	12262 UB	12217 UB	12220 UB	12260 UB R	12264 UB R	12202 UB	12263 UB	12261 UB
Ölçü (Ø xH)	1000x220x80	1000x200x80	1000x200x80	1000x150x60	1000x150x60	1200x150x50	1100x150x100	550x150x100
Ağırlık(yaklaşık)	3.5 kg	4.1 kg	3.7 kg	6.0 kg	6.0 kg	2.3 kg	4.25 kg	1.9 kg
Malzeme	PPC			PVC		PPC		

Araç Stoperleri-Kolon Koruyucular

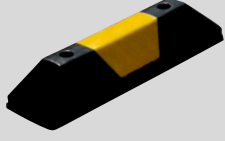

12235 UB
Araç Stoperi

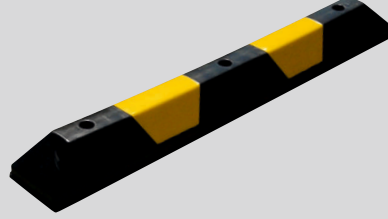

12233 UB
Araç Stoperi



12231 UB
Araç Stoperi



12216 UB R
Araç Stoperi



12296 UBR
Otopark Kolon
Köşe Koruyucu



12294 UBR
Otopark Kolon
Köşe Koruyucu



12292 UBR
Otopark Kolon
Köşe Koruyucu

Teknik Özellikler

Ürün Kodu	12235 UB	12233 UB	12231 UB	12216 UB R	12296 UBR	12294 UBR	12292 UBR
Ölçü (LxWxH)	550x150x100	1100x150x100	1800x150x100	500x160x100	70x120x800	70x120x800	90x140x900
Ağırlık(yaklaşık)	2.15kg	4.65 kg	7.5 kg	2.45 kg	1.9 kg	1.9 kg	1.85 kg
Malzeme	PPC				PVC		PVC-PE
Özellikler	Farklı renklerde görsel uyarı			Uç uca eklenerek şerit oluşturabilme	Reflektif bant	Reflektif bant	Reflektif bant
							Yönel uyarı
Belgelendirme	DIN EN ISO 9001:2008						
Uygulama	Ø 18 x L90 x Ø 10 vida dübel				Ø 8 x H30 mm plastik vida dübel		

Trafik Güvenlik Aynaları



1 2226TGA

1 2227TGA

1 2228TGA

1 2229TGA

1 2248TGA

1 2246TGA



1 2267TGA



1 2265TGA



E 255 GA



E 134 GA



E 135 GA

Teknik Özellikler

											
Ürün Kodu	12226 TGA	12227 TGA	12228 TGA	12229 TGA	12248 TGA	12246 TGA	12267 TGA	12265 TGA	E 255 GA	E 134 GA	E 135 GA
Ölçü (HxW)	(Φ)800 mm	(Φ)800 mm	(Φ)600 mm	(Φ)600 mm	600x800 mm	600x800 mm	400x600 mm	400x600 mm	Φ 600 mm Φ 800 mm Φ 900 mm Φ 1000 mm Φ 1200 mm	190x380 mm	(Φ)400 mm
Ağırlık(yaklaşık)	6.0 kg	6.0 kg	4.0 kg	4.0 kg	5.4kg	5.4 kg	3.6kg	3.6 kg	9.0 kg	6.0 kg	8.0 kg
Malzeme	PPC										
Özellikler	2 mm Akrilik Mercek Ayna										
Belgelendirme	DIN EN ISO 9001:2008										
Uygulama	Φ 50- Φ 75 mm arası direğe M Φ 8 özel aparat, vida dübel ile direkt duvara										

Güvenlik Kıyafetleri



E 124 RK T



E 124 RK Y

ÇİFT TARAFLI REFLEKTİFLİ İŞÇİ KABANI

- Model : Çift Taraflı
- Renk : Floresan Sarı- Turuncu
- Kumaş : %100 Miflonlu
- Beden : M - L - XL - XXL



E 123 RM Y



E 122 RM T

ÇİFT TARAFLI ve MİFLONLU İŞÇİ YELEĞİ

- Model : Fermuarlı - Reflektifli
- Renk : Floresan Turuncu
- Kumaş : %100 Miflonlu
- Beden : S - M - L - XL - XXL



E 127 RM Y

ÇİFT TARAFLI REFLEKTİFLİ İŞÇİ MONTU

- Model : Çift Taraflı
- Renk : Floresan Sarı
- Kumaş : %100 Miflonlu
- Beden : M - L - XL - XXL



E 114 RY T

BELDEN ve O MUZDAN TEK ŞERİTLİ YELEK

- Model : Yapışkanlı - Reflektifli
- Renk : Floresan Sarı - Turuncu
- Kumaş : %100 Raşel
- Beden : S - M - L - XL - XXL



E 117 RY T

BELDEN ÇİFT ŞERİTLİ YELEK

- Model : Yapışkanlı - Reflektifli
- Renk : Floresan Sarı
- Kumaş : %100 Raşel
- Beden : S - M - L - XL - XXL

Kasis Kapanı-Kablo Koruyucu Kasis



1 2 2 9 8 U B

Kablo Koruyucu Kasis
(600x500x75)

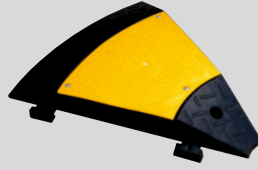

1 2 2 9 9 U B

Kablo Koruyucu Köşe
(600x500x75)

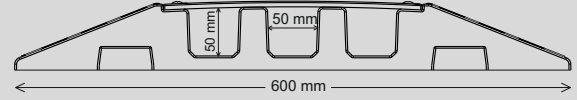
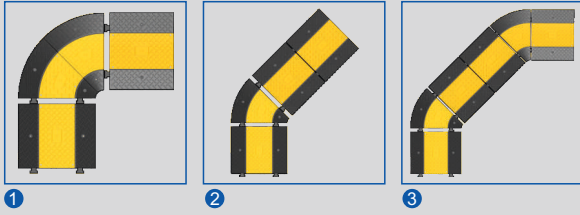

1 2 2 9 0 U B

Otopark Kasis Kapanı

1 2 2 9 1 U B K

Otopark Kasis
Kapanı Kapağı



özel durumlar için
kapanı ters yönde kullanma kilidi



UYARI ! Uygulanacak Zemin Düzgün ve Temiz Olmalıdır.

Teknik Özellikler				
Ürün Kodu	12290 UB	12291 UB K	12298 UB	12299 UB
Ölçü (LxWxH)	500x500x60	500x90x60	600x500x75	600x500x75
Ağırlık(yaklaşık)	7.3 kg	0.700 kg	8.7 kg	3.0 kg
Malzeme	PPC			
Özellikler	Reflektif bant	-	Max. Ø 50mm boru ve kablo kanalı	
	Tek yönlü uyarı	-	3 Kanallı	
Belgelendirme	DIN EN ISO 9001:2008			
Uygulama	Birbirine ilave edilerek Ø 18xL90x Ø 10 mm vida ve dübelle uygulama			

Kauçuk Şaseli Yol Kasisi

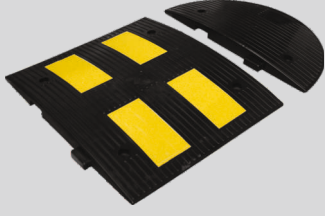

12108YK
Yol Kasisi

12109YKK
Kasisi Kapağı



12110YK
Yol Kasisi

12111YKK
Kasisi Kapağı

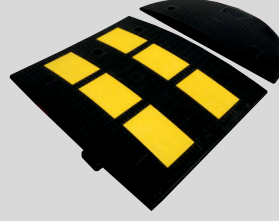

12116YK
Yol Kasisi

12109YKK
Kasisi Kapağı



12104YK
Yol Kasisi

12105YKK
Kasisi Kapağı



12106YK
Yol Kasisi

12107YKK
Kasisi Kapağı



12112YK
Yol Kasisi

12113YKK
Kasisi Kapağı

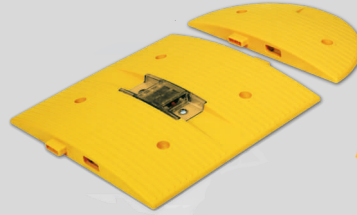

11938SL
Flaşörlü Yol Kasisi

11940SLK
Kasisi Kapağı



12100YK
Yol Kasisi

12101YKK
Kasisi Kapağı



12102YK
Yol Kasisi

12103YKK
Kasisi Kapağı

Teknik Özellikler

Ürün Kodu	12112 YK	12113 YK K	11938 SL	11940 SL K	12100 YK	12101 YK K	12102 YK	12103 YKK
Ölçü (AxH)	500x500x45	500x250x45	500x500x45	500x250x45	250x350x50	250x100x50	300x333x40	300x100x40
Ağırlık(yaklaşık)	3.13 kg	1.1 kg	3.13 kg	1.1 kg	1.5 kg	0.360 kg	1.33 kg	0.250 kg
Malzeme	PPC							

Teknik Özellikler

Ürün Kodu	12116YK	12109YKK	12108YK	12109YKK	12110YK	12111YKK	12104 YK	12105YKK	12106YK	12107YKK
Ölçü (AxH)	600x500x45	600x300x45	600x500x45	600x300x45	400x500x40	400x200x40	500x330x45	500x250x45	400x500x40	400x200x40
Ağırlık(yaklaşık)	9.32 kg	3.4 kg	9.32 kg	3.4 kg	6.5 kg	1.65 kg	6.25 kg	3.0 kg	6.5 kg	1.65 kg
Malzeme	PVC Compound									

Yol İşaretleme Butonları



12011 YB
Ankarajlı Yol Butonu



12007 YB
Metal Yol Butonu



12009 YB
Cam Kedi Gözülü
Yol Butonu



12006 YB
Oval Yol Butonu

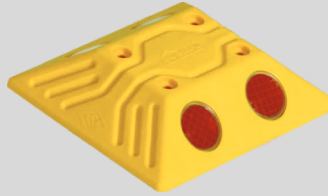

12000 YB
Klasik Yol Butonu



12004 YB
Ufo Yol Butonu



12005 YB
Oto Yol Butonu



12003 YB
Set Yol Butonu



12002 YB
Kare Yol Butonu

Teknik Özellikler

Ürün Kodu	12011 YB	12007 YB	12009 YB	12006 YB	12004 YB	12003 YB	12000 YB	12005 YB	12002 YB
Ölçü (LxWxH)	100x100x21	120x120x28	100x100x21	120x220x28	120x140x25	100x220x32	125x150x32	105x105x20	120x120x28
Ağırlık(yaklaşık)	0.375 kg	0.290 kg	0.150 kg	0.220 kg	0.120 kg	0.240 kg	0.190 kg	0.110 kg	0.170 kg
Malzeme	Al		ABS	PPC			ABS	PPC	
Özellikler	Kedi Gözü			Reflektif Mercek					
	Çift Yönlü Uyarı								
	3+3 Kedi Gözü	2+2 Kedi Gözü	3+3 Kedi Gözü	2+2 Reflektif Mercek	3+3 Reflektif Mercek	2+2 Reflektif Mercek	1+1 Reflektif Mercek	2+2 Reflektif Mercek	
Belgelendirme	DIN EN ISO 9001:2008								
Uygulama	Ø 20 x L50 saplama epoksi yapıştırma		Ø 14 x L70 x Ø 8 mm vida ve dübel ile zemine			Ø 6 x L105 mm burgulu çivi ile zemine			

Solar Yol İşaretleme Butonları

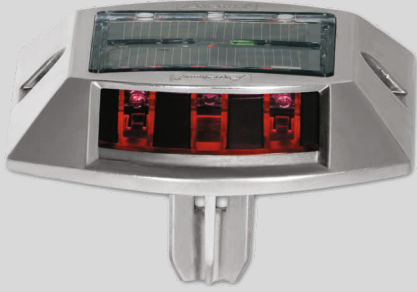

11924 SL K

Solar Yol İşaretleme Butonu



11926 SL S

Solar Yol İşaretleme Butonu



11920 SL K

Solar Yol İşaretleme Butonu

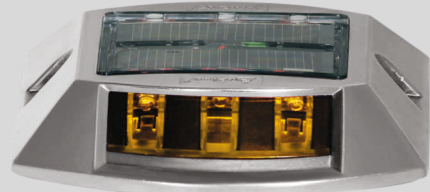

11922 SL S

Solar Yol İşaretleme Butonu

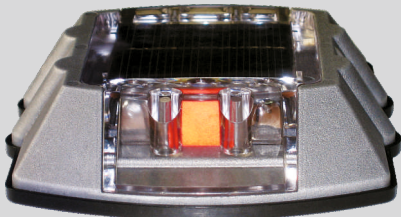

11921 SL K



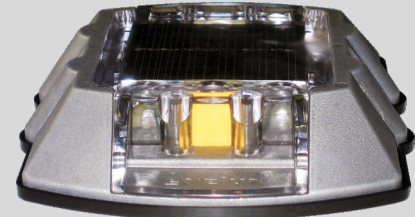

Solar Yol İşaretleme Butonu

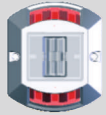

11923 SL S

Solar Yol İşaretleme Butonu

Teknik Özellikler

						
Ürün Kodu	11924 SL K	11926 SL S	11920 SL K	11922 SL S	11921 SL K	11923 SL S
Ölçü (LxWxH)	125x145x28	125x145x28	125x145x28	125x145x28	120x135x28	120x135x28
Ağırlık(yaklaşık)	0.480 kg	0.480 kg	0.450 kg	0.450 kg	0.575 kg	0.575 kg
Malzeme	Al Gövde - PC Led Koruyucu					
Özellikler	Solar Güçle Çalışan Çift Yönlü Uyarı Flaşörü					
	3+3 LED					
	Darbe absorbe edici platform					
Koruma Sını	Gövde Sızdırmazlık IP 65 Özelliğine Sahip					
Belgelendirme	DIN EN ISO 9001:2008					
Uygulama	Ø30 x H50 mm saplama		Ø14 x L70 x Ø8 mm vida ve dübel ile			

Teknik Özellikler

Solar Panel	Tip	monocrystalline silicon cell
	Ölçü	60 x 54 mm
	Voltaj	3 V
	Akım	120 mA
Batarya	Malzeme	Ni-MH
	Voltaj	1.2 V
	Akım	2000 mA/h
	Renk	Sarı-Kırmızı
LED	Ölçü	Ø5 mm
	Flaş Sayısı	120 f/dk
	Uyarı Mesafesi	300 m
	Çalışma Süresi	Tüm Gece / Güneşli Hava
	Çalışma Sıcaklığı	-20°C / +60°C

El Tipi Uyarıcı İşaretleri



E 240 IJ

IŞIKLI JOB

- Malzeme :Metal-PVC
- Uzunluk : 335mm
- Üç kademe flaş modu vardır
- 3 adet ince pil ile çalışır
- Mıknatıslıdır



E 265 IJ

IŞIKLI JOB

- Flaş :150Flaş/dk
- Uzunluk : 530mm
- Tek kademe flaş modu vardır



E 170 IDG

IŞIKLI DUR GEÇ EL İŞARETLERİ

- Bir yüzeyi yeşil, diğer yüzeyi kırmızıdır.
- Alkaline ve Ni-Cd pil ile çalışmaktadır.
- Ampüller birbirinden bağımsız olarak yakılabilir.



E 172 DG

- Levha Çapı: 280 mm
- Sap Ölçü : 170xØ25mm



E 171 DG

- Levha Çapı: 390 mm
- Sap Ölçü : 170xØ25mm

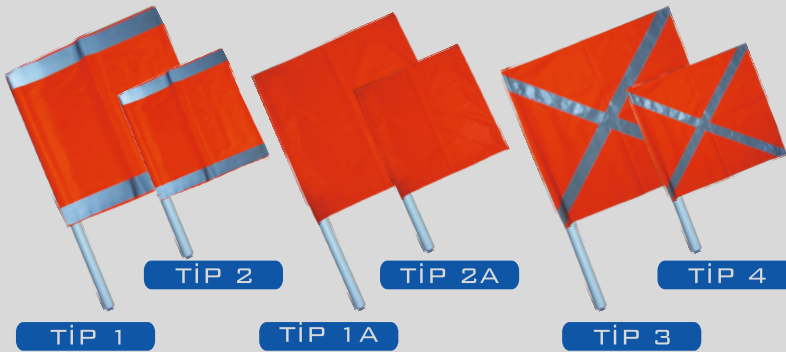

TİP 1

TİP 2

TİP 1A

TİP 2A

TİP 4

TİP 3

UYARICI EL İŞARET BAYRAKLARI

- Tip 1 : 650 x 650 mm Reflektifli
- Tip 1A: 650 x 650 mm Reflektifsiz
- Tip 2 : 450 x 450 mm Reflektifli
- Tip 2A: 450 x 450 mm Reflektifsiz
- Tip 3 : 650 x 650 mm Reflektifli
- Tip 4 : 450 x 450 mm Reflektifli

Emniyet Şeridi - Stopper - Grillant

OTOPARK ARAÇ TAHDİT APARATI

- Otoparklarda araçların park sınırını belirlemek amacı ile kullanılmaktadır.
- Montajı çok kolaydır.
- Açık veya kapalı otoparklarda rahatlıkla uygulanabilmektedir.

- Malzeme : Demir Boru
- Uzunluk : 1500mm
- Boru Çapı : 60cm
- Renk : Sarı



E 245 O T A S



E 138 E Ş

EMNİYET ŞERİDİ

- Şehir içi yol, kazı veya inşaat çalışması yapılan alanlarda hızlı bir şekilde barikat kurulması amacı ile kullanılır.

- Uzunluk: 200mt -500mt
- Renk : Kırmızı- Beyaz



E 143 GR

GRİLLANT

- Küçük boyutlu onarım yapılan yerlerin etrafını işaretlemek için kullanılır.
- Gövdenin üst tarafında bulunan delikli parça birbirinden bağımsız olarak taşıma ipine asılarak uygulanır.

Reflektörler

OTOKORKULUK REFLEKTÖRLERİ

- Galvanizli sacdan imal edilmektedir.
- Kırmızı ve Beyaz reflektif kullanılmaktadır.
- Tek veya iki yönlü Yüksek Performanslı Reflektif Malzeme uygulanır.
- Yol geometrisine göre değişken aralıklarla çelik otokorkuluklar üzerine monte edilir.

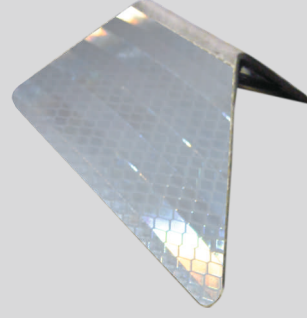

E 129 OR B



E 128 OR K

GENİŞ AÇILI PRİZMATİK REFLEKTÖR

- Gövde : Alüminyum Plaka
- Ölçü : 850mm x 150mm
- Kalınlık: 1mm
- Renk : Beyaz - Kırmızı

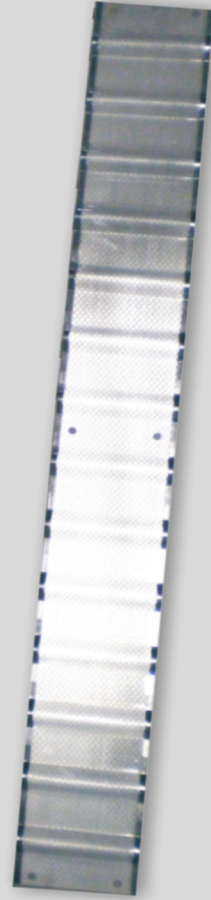

E 206 PR B



E 205 PR K

Görme Engelliler Zemin İşaretleme

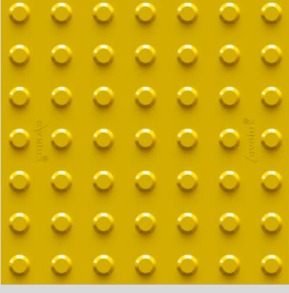

PL 8010

Engelli Uyarı Yüzeyi
(0.8x40x40 cm)

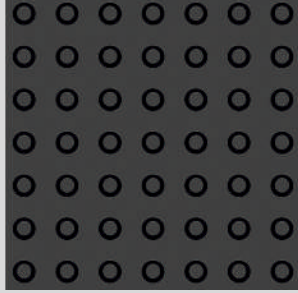

PL 8011

Engelli Uyarı Yüzeyi
(0.8x40x40 cm)



PL 8012

Engelli Uyarı Yüzeyi
(0.8x40x40 cm)

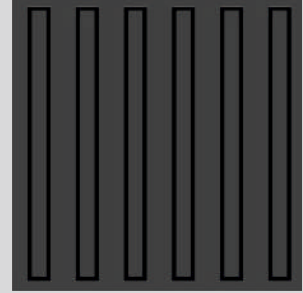

PL 8013

Engelli Uyarı Yüzeyi
(0.8x40x40 cm)

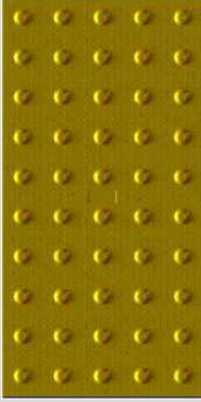

PL 8014

Engelli Uyarı Yüzeyi
(0.8x30x60 cm)

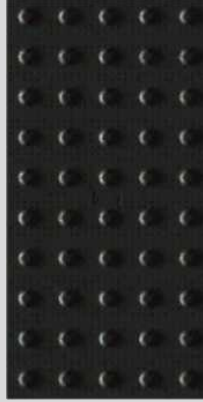

PL 8015

Engelli Uyarı Yüzeyi
(0.8x30x60 cm)

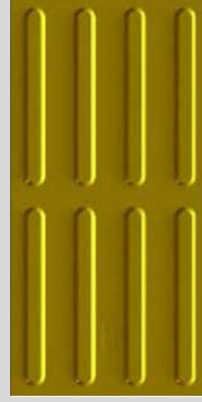

PL 8016

Engelli Uyarı Yüzeyi
(0.8x30x60 cm)



PL 8017

Engelli Uyarı Yüzeyi
(0.8x30x60 cm)

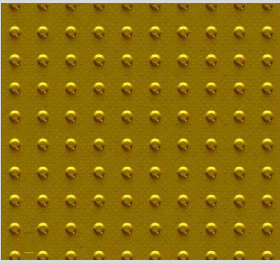

PL 8018

Engelli Uyarı Yüzeyi
(0.8x58x58 cm)

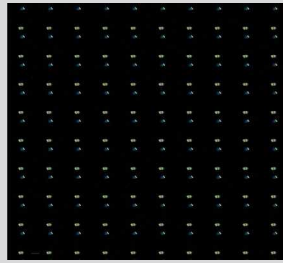

PL 8019

Engelli Uyarı Yüzeyi
(0.8x58x58 cm)

Özellikler

- Hissedilebilir takip yüzeyi TPU malzemeden üretilmektedir.
- Hissedilebilir takip yüzeyi zemine epoksi ile uygulanır.

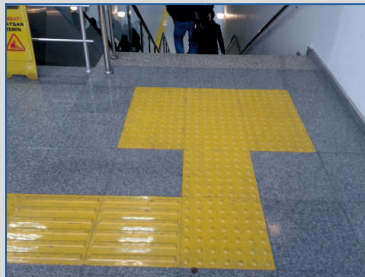

Yapışkanlı Zemin Uyarı İşaretleri

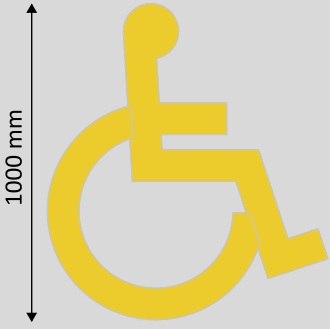

PL 5012

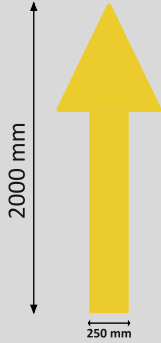

PL 5014

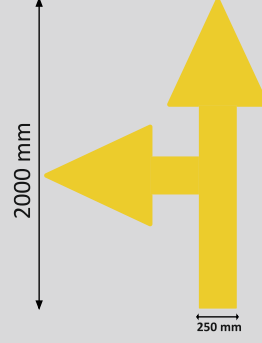

PL 5017



PL 5018

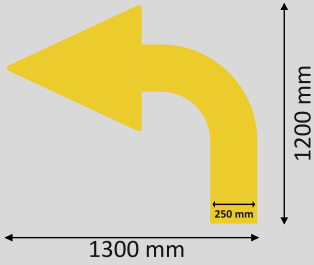

PL 5015

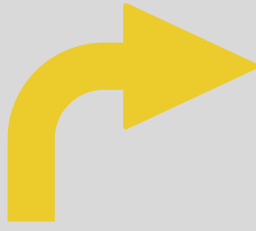

PL 5016



PL 5034



PL 5036



PL 5032



PL 5042

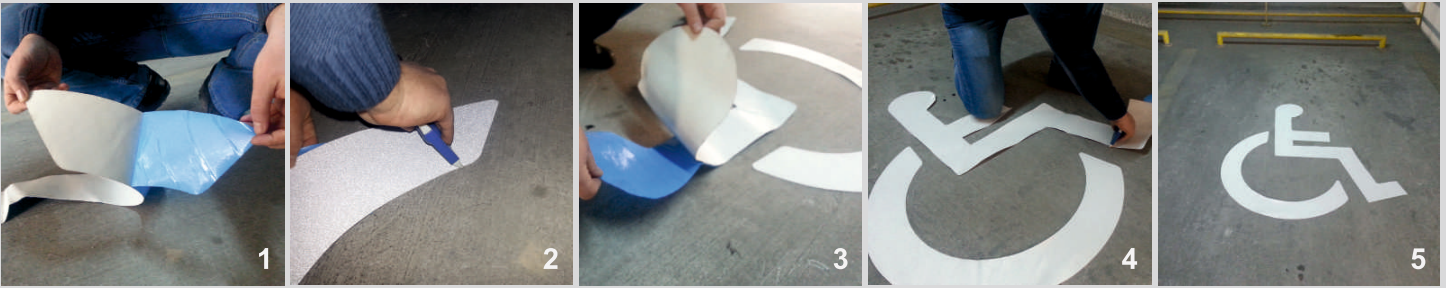

Özellikler :

Zemine kuvvetli tutunan bir yapışkan, cam kürecikli üst katman, iyi yansımaya, esnek, hava koşullarına dayanıklılık, kolay uygulama

Kullanım Alanları :

Dayanıklı yol işaretleri, otoparklar, süpermarketler, fabrikalar, uyarı alanları, yaşam alanları, limanlar, hava alanları, holler, stadyumlar, eğlence mekanları vs. gibi yer işaretlemelerinde kullanılır.

Yapışkanlı Zemin İşaretleme Bantları

PL5001-SARI

Özellik	Standart Değer	Test Değeri	Test Yöntemi
Kalınlık (mm)	1.4	1.5	ASTM D4325
Performans (mcd.m ⁻² x ⁻¹)	>175	186	ASTM D4061
Yapışkanlık (N/25mm)	>16	18.5	ASTM D1000
Kaydırmazlık (BPN)	45	45	ASTM E303

Size: 5 cm x 33 m/roll (Rubber)

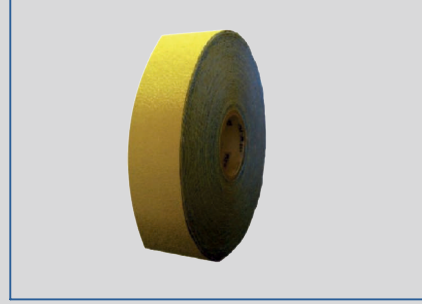

PL5002-SARI

Özellik	Standart Değer	Test Değeri	Test Yöntemi
Kalınlık (mm)	1.4	1.5	ASTM D4325
Performans (mcd.m ⁻² x ⁻¹)	>175	186	ASTM D4061
Yapışkanlık (N/25mm)	>16	18.5	ASTM D1000
Kaydırmazlık (BPN)	45	45	ASTM E303

Size: 10 cm x 33m/roll (Rubber)



PL10002-SARI

Özellik	Standart Değer	Test Değeri	Test Yöntemi
Kalınlık (mm)	2.4	2.5	ASTM D4325
Performans (mcd.m ⁻² x ⁻¹)	>175	186	ASTM D4061
Yapışkanlık (N/25mm)	>16	18.5	ASTM D1000
Kaydırmazlık (BPN)	45	45	ASTM E303

Size: 10cm x 33 m/roll (Rubber)

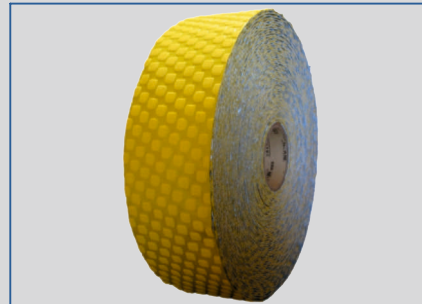

Özellikler :

Zemine kuvvetli tutunan bir yapışkan, cam kürecikli üst katman, iyi yansıma, esnek, hava koşullarına dayanıklılık, kolay uygulama

Kullanım Alanları :

Dayanıklı yol işaretleri, otoparklar, süpermarketler, fabrikalar, uyarı alanları, yaşam alanları, limanlar, hava alanları, holler, stadyumlar, eğlence mekanları vs. gibi yer işaretlemelerinde kullanılır.

Reflektif Bantlar



ETR-5111-Red/White

Size : 5 cm x 10 m/roll
Per. : 80 cd/lux
Type : Glass Beads



ETR-5121-Yellow/Black

Size : 5 cm x 10 m/roll
Per. : 50 cd/lux
Type : Glass Beads



ETR-5112-Red/White

Size : 10 cm x 10 m/roll
Per. : 80 cd/lux
Type : Glass Beads



ETR-5122-Yellow/Black

Size : 10 cm x 10 m/roll
Per. : 50 cd/lux
Type : Glass Beads



ETR-5131-White

Size : 5 cm x 10 m/roll
Per. : 80 cd/lux
Type : Glass Beads



ETR-5141-Yellow

Size : 5 cm x 10 m/roll
Per. : 50 cd/lux
Type : Glass Beads



ETR-5151-Red

Size : 5 cm x 10 m/roll
Per. : 30 cd/lux
Type : Glass Beads



ETR-5161-Blue

Size : 5 cm x 10 m/roll
Per. : 4.0 cd/lux
Type : Glass Beads

Araç İşaretleme Bantları



EMR-004-F.Orange

Size : 5 cm x 10 m/roll
Per. : 250 cd/lux
Type : Microprismatic



EMR-011-Blue

Size : 5 cm x 10 m/roll
Per. : 45 cd/lux
Type : Microprismatic



EMR-008-F.Green

Size : 5 cm x 10 m/roll
Per. : 80 cd/lux
Type : Microprismatic



EGR-001-White

Size : 5 cm x 30 m/roll
Per. : 350 cd/lux
Type : Microprismatic



EGR-003-Yellow

Size : 5 cm x 30 m/roll
Per. : 300 cd/lux
Type : Microprismatic



EGR-007-Red

Size : 5 cm x 30 m/roll
Per. : 70 cd/lux
Type : Microprismatic

Dikdörtgen Uyarı Levhaları



317AR

Yolda Çalışma



316AR

Dikkat



315AR

Soldan Gidiniz



314AR

Sağdan Gidiniz



313AR

İki Yönlü Trafik



312AR

Öndeki Taşıtı Geçmek Yasaktır



311AR

Karşıdan Gelene Yol Ver



310AR

Soldan Daralan Kaplama



309AR

Sağdan Daralan Kaplama



308AR

Azami Hız Sınırlaması



325AR

Tehlikeli Viraj Yön Levhası
İki Yönlü Uyarı Etiketi



318AR

Engelli Park Yeri



130AR

Dikkat



131AR

Yolda Çalışma



133AR

Sağdan Daralan Kaplama



34AR

Soldan Daralan Kaplama



132AR

Her İki Taraftan Daralan Kaplama



135AR

İki Yönlü Trafik



141AR

Kasisli Yol



169AR

Gevşek Malzemeli Zemin



222AR

Sola Mecburi Yön
İki Yönlü Uyarı Etiketi

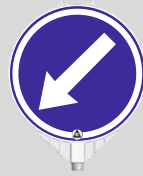

229AR

Soldan Gidiniz

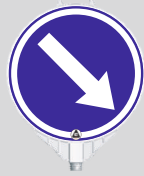

230AR

Sağdan Gidiniz

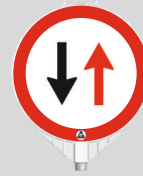

234AR

Karşıdan Gelene Girişi Olmayan Yol Ver



221AR

Girişi Olmayan Yol



239AR

Dur



233AR



Azami Hız Sınırlaması



295AF

Ultra Park Yasak Levhası
İki Yönlü Uyarı Etiketi

Teknik Özellikler

			
Ölçü (WxH)	350 x 410 mm	(H) 390 mm	(Ø) 380 mm
Malzeme	PPC		
Reflektif	30 cd/lux		

Üçgen ve Yuvarlak Uyarı Levhaları



196 A

Ultra Yuvarlak
Levha



110 A

Üçgen
Levha



111 A

Dikdörtgen
Levha



113 A

Yıldız
Levha



114 A

Dekoratif
Levha



120 A

Yuvarlak
Levha



124 AF

Park Yasak
Levhası



126 A

Koni Lamba
ve Levha
Takma Aparatı



194 A

Delineator Lamba
ve Levha Takma
Aparatı



190 A

PVC Koni
Ağırlığı



192 A

Güvenlik Barikat
Kelepçesi

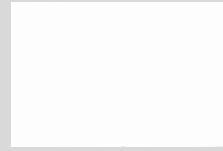

164 A

PVC Boş
Uyarı Levhası



142 A

PVC Boş
Uyarı Levhası



128 A

Plastik Zincir
25mt/Paket



129 A

Plastik Zincir
25mt/Paket



127 A

Plastik Zincir
3mt/Paket



123 A

Plastik Zincir
3mt/Paket



149 A

Bariyer Levha
Tutucu Profili

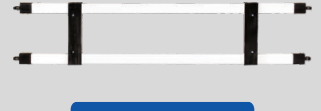

150 A

Bariyer Levha
Tutucu Profili



159 A

Trifon Asfalt
Montaj Vidası
ve Dübeli



163 A

Trifon Beton
Montaj Vidası
ve Dübeli



160 A

Trifon Montaj
Vidası ve
Dübeli



176 A

Trifon
Montaj
Vidası



161 A

Beton
Montaj
Çivisi



173 A

Beton Dübeli



172 A

Asfalt Dübeli



174 A

Koni Kancası

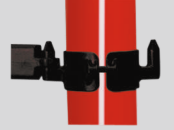

155 A

Dikme Profil
Kancası

Teknik Özellikler

Ürün Kodu	128 A	129 A	127 A	175 A	123 A	152 A R	12210 UB
Ölçü (LxWxH)	25 m	25 m	3 m	70x28	3 m	1500x50	340 x 110 x 34 mm
Malzeme	PP	PP	PP	PP	PP	PVC	PC
Özellikler	Kırmızı-Beyaz	Sarı-Siyah	Kırmızı-Beyaz	-	Sarı-Siyah	-	-
Uygulama	-	-	-	-	-	-	M5 vida/epoksi yapıştırma



175 A

Zincir Klipsi

Teknik Özellikler

Ürün Kodu	196 A	110 A	111 A	120 A	124 A F	113 A	114 A	126 A	194 A	174 A
Ölçü	Ø 380	(H)390	350 x 410	Ø 280	Ø 280	300 x 300	315 x 340	70 x 105	Ø 93 x 82	Ø 40
Malzeme	PPC	PPC	PPC	PPC	PPC	PPC	PPC	ABS	PPC	PPC

Teknik Özellikler

Ürün Kodu	164 A	149 A	142 A	150 A	155 A	192 A	190 A	159 A	163 A	160 A	176 A	161 A	173 A	172 A
Ölçü (WxH)	1250x750	1500x750	900x315	1500x315	Ø110	130x35	385x50	18x90x10	14x70x8	14x70x8	10x105	6x105	14x70x8	18x90x10
Malzeme	PVC	PVC	PVC	PVC	PA	PA	PVC	-	-	-	-	-	PP	PP

TEHLİKE ve UYARI İŞARETLERİ



(T-1a) SAĞA TEHLİKELİ VİRAJ



(T-1b) SOLA TEHLİKELİ VİRAJ



(T-2a) SAĞA TEHLİKELİ DEVAMLILIK VİRAJLARI



(T-2b) SOLA TEHLİKELİ DEVAMLILIK VİRAJLARI



(T-3a) TEHLİKELİ EĞİM (İniş)



(T-3b) TEHLİKELİ EĞİM (Çıkış)



(T-4a) HER İKİ YARITAN DARALAN KAPLAMA



(T-4b) SAĞDAN DARALAN KAPLAMA



(T-4c) SOLDAN DARALAN KAPLAMA



(T-5) AÇILAN KÖPRÜ



(T-6) DENİZ VEYA NEHRİN KİYISINDA BİTEN YOL



(T-7) KASISLI YOL



(T-8) KAYGAN YOL



(T-9) GEVŞEK MALZEMELİ ZEMİN



(T-10) GEVŞEK ŞEV



(T-11) YAYA GEÇİDİ



(T-12) OKUL GEÇİDİ



(T-13) BİSKİLET GEÇEBİLİR



(T-14a) EHLİ HAYVANLAR GEÇEBİLİR



(T-14b) VAHŞİ HAYVANLAR GEÇEBİLİR



(T-15) YOLDA ÇALIŞMA



(T-16) İŞIKLI İŞARET ÇİHAZI



(T-17) HAVAYALANI-HAVALİMANI (Alçak Uçuş)



(T-18) YANDAN RÜZGAR



(T-19) İKİ YÖNLÜ TRAFİK



(T-20) DİKKAT



(T-21) KONTROLSÜZ KAVŞAK



(T-22a) ANA YOL-TALI YOL KAVŞAĞI



(T-22b) ANA YOL-TALI YOL KAVŞAĞI



(T-22c) ANA YOL-TALI YOL KAVŞAĞI



(T-22d) ANA YOL-TALI YOL KAVŞAĞI



(T-22e) ANA YOL-TALI YOL KAVŞAĞI



(T-23a) SAĞDAN ANA YOLA GİRİŞ



(T-23b) SOLDAN ANA YOLA GİRİŞ



(T-24) DÖNEL KAVŞAK



(T-25) KONTROLLÜ DEMİRYOLU GEÇİDİ



(T-26) KONTROLSÜZ DEMİRYOLU GEÇİDİ



(T-27a) KONTROLSÜZ DEMİRYOLU GEÇİDİ (Tek Hat)



(T-27b) KONTROLSÜZ DEMİRYOLU GEÇİDİ (En az 2 Hat)



(T-28a) DEMİRYOLU GEÇİDİ YAKLAŞIM LEVHALARI (Sağ)



(T-28b) DEMİRYOLU GEÇİDİ YAKLAŞIM LEVHALARI (Sol)



(T-29a) DEMİRYOLU GEÇİDİ YAKLAŞIM LEVHALARI (Sağ)



(T-29b) DEMİRYOLU GEÇİDİ YAKLAŞIM LEVHALARI (Sol)



(T-30a) DEMİRYOLU GEÇİDİ YAKLAŞIM LEVHALARI (Sağ)



(T-30b) DEMİRYOLU GEÇİDİ YAKLAŞIM LEVHALARI (Sol)



(T-31a) KÖPRÜ BAŞI LEVHASI (Sağ)

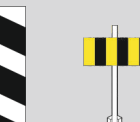

(T-31b) KÖPRÜ BAŞI LEVHASI (Sol)

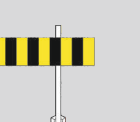

(T-32) ENGEL İŞARETİ



(T-33a) TEHLİKELİ VİRAJ YÖN LEVHASI



(T-33b) TEHLİKELİ VİRAJ YÖN LEVHASI



(T-33c) TEHLİKELİ VİRAJ YÖN LEVHASI



(T-33d) ONARIM YAKLAŞIM LEVHASI (Sağ)



(T-33e) ONARIM YAKLAŞIM LEVHASI (Sol)



(T-34a) REFÜJÜ BAŞI EK LEVHASI (Sağ)



(T-34b) REFÜJÜ BAŞI EK LEVHASI (Sol)



(T-35) DÖNÜŞ ADAZI EK LEVHASI



(T-36) DÜŞÜK BANKET



(T-37) GİZLİ BUZLANMA



(T-38) TRAFİK SIKIŞIKLIĞI



(T-39) TRAMVAY HATTI İLE OLUŞAN KAVŞAK

TRAFİK TANZİM İŞARETLERİ



(TT-1) YOL VER



(TT-2) DUR



(TT-3) KARŞIDAN GELENE YOL VER



(TT-4) GİRİŞ OLMAYAN YOL



(TT-5) TAŞIT TRAFİĞİNE KAPALI YOL



(TT-6) MOTOSİKLET HARİÇ MOTORLU TAŞIT TRAFİĞİNE KAPALI YOL



(TT-7) MOTOSİKLET GİREMEZ



(TT-8) BİSKİLET GİREMEZ



(TT-9) MOTORLU BİSKİLET GİREMEZ



(TT-10a) KAMYON GİREMEZ



(TT-10b) OTOBÜS GİREMEZ



(TT-11) TREYLER GİREMEZ



(TT-12) YAYA GİREMEZ



(TT-13) AT ARABASI GİREMEZ



(TT-14) EL ARABASI GİREMEZ



(TT-15) TRAKTÖR GİREMEZ



(TT-16a) BELİRLİ MİKTARLARDAN FAZLA PATLAYICI VE PARLAYICI MADDE TAŞIYAN TAŞIT GİREMEZ



(TT-16b) TEHLİKELİ MADDE TAŞIYAN TAŞIT GİREMEZ



(TT-17) BELİRLİ MİKTARLARDAN FAZLA SU KİRLİTİCİ MADDE TAŞIYAN TAŞIT GİREMEZ



(TT-18) MOTORLU TAŞIT GİREMEZ



(TT-19) TAŞIT GİREMEZ



(TT-20) GENİŞLİĞİ ... METREDEN FAZLA OLAN TAŞIT GİREMEZ



(TT-21) YÜKSEKLİĞİ ... METREDEN FAZLA OLAN TAŞIT GİREMEZ



(TT-22) UZUNLUĞU ... METREDEN FAZLA OLAN TAŞIT GİREMEZ



(TT-23) DİNGİL BASINA ... TONDAN FAZLA YÜK DÜŞEN TAŞIT GİREMEZ



(TT-24) YÜKLÜ AĞIRLIĞI ... TONDAN FAZLA OLAN TAŞIT GİREMEZ



(TT-25) ÖNDEKİ TAŞIT ... METREDEN DAHA YAKIN TAKİP EDİLEMEZ



(TT-26a) SAĞA DÖNÜLMEZ



(TT-26b) SOLA DÖNÜLMEZ



(TT-26c) U DÖNÜŞÜ YAPILMAZ



(TT-27) ÖNDEKİ TAŞITI GEÇMEK YASAKTIR



(TT-28) KAMYONLAR İÇİN ÖNDEKİ TAŞITI GEÇMEK YASAKTIR



(TT-29a) AZAMI HIZ SINIRLAMASI



(TT-29b) OKUL BÖLGESİ AZAMI HIZ SINIRI



(TT-30) SESLİ İKAZ CİHAZLARININ KULLANIMI YASAKTIR



(TT-31) GÜMRÜK (DURMADAN GEÇMEK YASAKTIR)



(TT-32) BÜTÜN YASAKLAMA VE KISITLAMALARIN SONU



(TT-33) HIZ SINIRLAMASI SONU



(TT-34a) GEÇME YASAĞI SONU



(TT-34b) KAMYONLAR İÇİN GEÇME YASAĞI SONU



(TT-35a) SAĞA MECBURİ YÖN



(TT-35b) SOLA MECBURİ YÖN



(TT-35c) İLERİ MECBURİ YÖN



(TT-35d) İLERİ VE SAĞA MECBURİ YÖN



(TT-35e) İLERİ VE SOLA MECBURİ YÖN



(TT-35f) SAĞA VE SOLA MECBURİ YÖN



(TT-35g) İLERİDEN SAĞA MECBURİ YÖN



(TT-35h) İLERİDEN SOLA MECBURİ YÖN



(TT-36a) SAĞDAN GİDİNİZ



(TT-36b) SOLDAN GİDİNİZ



(TT-36c) HER İKİ YANDAN GİDİNİZ



(TT-37) ADA ETRAFINDA DÖNÜNÜZ



(TT-38a) MECBURİ BİSKİLET YOLU



(TT-38b) MECBURİ BİSKİLET YOLU SONU



(TT-39a) MECBURİ YAYA YOLU



(TT-39b) MECBURİ YAYA YOLU SONU



(TT-40a) MECBURİ ATLI YOLU



(TT-40b) MECBURİ ATLI YOLU SONU



(TT-41a) MECBURİ ASGARİ HIZ



(TT-41b) MECBURİ ASGARİ HIZ SONU



(TT-42a) ZİNCİR TAKMAK MECBURİDİR



(TT-42b) ZİNCİR TAKMA MECBURİYETİ SONU



(TT-44a) YAYALAR VE BİSKİLETLİLER TARAFINDAN KULLANILABİLEN YOL



(TT-44b) YAYALAR VE BİSKİLETLİLER TARAFINDAN KULLANILABİLEN YOL SONU



(TT-45a) YAYALAR VE BİSKİLETLİLER İÇİN AYRI AYRI KULLANILABİLEN YOL



(TT-45b) YAYALAR VE BİSKİLETLİLER İÇİN AYRI AYRI KULLANILABİLEN YOL SONU



(TT-43a) TEHLİKELİ MADDE TAŞIYAN TAŞITLARIN İZLEYECEKLERİ MECBURİ YÖN

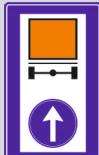

(TT-43b) TEHLİKELİ MADDE TAŞIYAN TAŞITLARIN İZLEYECEKLERİ MECBURİ YÖN



(TT-43c) TEHLİKELİ MADDE TAŞIYAN TAŞITLARIN İZLEYECEKLERİ MECBURİ YÖN

BİLGİ İŞARETLERİ



BİLGİ İŞARETLERİ



(B-51a) ŞERİT DÜZENLEME LEVHALARI



(B-51b) ŞERİT DÜZENLEME LEVHALARI

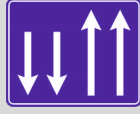

(B-51c) ŞERİT DÜZENLEME LEVHALARI



(B-51d) ŞERİT DÜZENLEME LEVHALARI



(B-52a) İKİ YÖNLÜ YOL



(B-52b) İKİ YÖNLÜ YOL



(B-53a) U DÖNÜŞÜ LEVHASI



(B-53b) U DÖNÜŞÜ LEVHASI (Sola Sıgırmalı)



(B-53c) U DÖNÜŞÜ LEVHASI (Sağa Sıgırmalı)



(B-53d) U DÖNÜŞÜ LEVHASI (Ait geçit)



(B-53e) U DÖNÜŞÜ LEVHASI (Ait Geçit)



(B-53f) U DÖNÜŞÜ LEVHASI (Ait Geçit)



(B-53g) U DÖNÜŞÜ LEVHASI (Üst Geçit)



(B-54) KARAYOLLARI BİLGİ LEVHASI

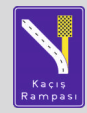

(B-55a) KAÇIŞ RAMPASI (Sağ)



(B-55b) KAÇIŞ RAMPASI (Sol)



(B-55c) KAÇIŞ RAMPASI



(B-55d) KAÇIŞ RAMPASI (Sağ)



(B-55e) KAÇIŞ RAMPASI (Sol)



(B-56) YAYA ÖNCELİKLİ YOL



(B-57) YAYA ÖNCELİKLİ YOLUN SONU



(B-58) İSTASYON



(B-59) TRAMVAY DURAĞI



(B-60) SANAYİ BÖLGESİ (OSB)



(B-61a) TRAFİK ELEKTRONİK DENETLEME



(B-61b) TRAFİK ELEKTRONİK DENETLEME



(B-61c) TRAFİK ELEKTRONİK DENETLEME

DURMA ve PARK ETME İŞARETLERİ



(P-1) PARK ETMEK YASAKTIR



(P-2) DURAKLAMAK ve PARK ETMEK YASAKTIR



(P-3a) PARK YERİ



(P-3b) PARK YERİ



(P-3c) PARK YERİ



(P-3d) PARK YERİ



(P-3e) PARK YERİ



(P-3f) KAPALI PARK YERİ



(P-3g) PARK YERİ (Metrodan Yararlanacaklar İçin)



(P-3h) PARK YERİ (Tramvaydan Yararlanacaklar İçin)

OTOYOL İŞARETLERİ



KAVŞAK İSİM LEVHASI



OTOYOL REJİMİ LEVHASI

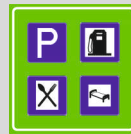

SERVİS ALANI LEVHASI

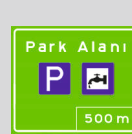

PARK ALANI LEVHASI



BAŞÜSTÜ ŞERİT SEÇİMİ LEVHASI



OGS LEVHASI



HGS LEVHASI



ŞERİT SEÇİMİ VE KULLANIMI LEVHALARI

PANELLER



(PL - 1) SÜREKLİLİK PANELİ



(PL - 2) MESAFE PANELİ

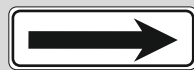

(PL - 3) YÖN PANELİ



(PL - 4) FAR PANELİ



(PL - 5) DUR PANELİ



(PL - 6) ÖZÜRLÜ SÜRÜCÜ PANELİ



(PL - 7) YAĞIŞ PANELİ



(PL - 8) PARK PANELİ

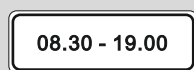

(PL - 9) SÜRE PANELİ



(PL - 10) TAŞIT PANELİ



(PL - 11) TAŞIT PANELİ



(PL - 12) HAYVAN PANELİ

YOL YAPIM BAKIM ONARIM İŞARETLERİ



(YB-1c)
YOL ONARIMI



(YB-1d)
KÖPRÜ ONARIMI



(YB-1a)
YOL YAPIMI



(YB-1b)
ASFALT YAPIMI



(T-15) YOLDA
ÇALIŞMA



(TT-27) ÖNDEKİ
TAŞITI GEÇMEK
YASAKTIR



(TT-29)
AZAMI HIZ
SINIRLAMASI



(TT-32) BÜTÜN
YASAKLAMA ve
KISITLAMALARIN
SONU



(TT-36a)
SAĞDAN
GİDİNİZ



(TT-36b)
SOLDAN
GİDİNİZ



(T-20)
DİKKAT



(T-19)
İKİ YÖNLÜ
TRAFİK



(T-4b) SAĞDAN
DARALAN
KAPLAMA



(T-4c) SOLDAN
DARALAN
KAPLAMA



(TT-3)
KARŞIDAN
GELENE YOL
VER



(TT-5)
TAŞIT
TRAFİĞİNE
KAPALI YOL



(YB-4a)
ŞERİT
DÜZENLEME
LEVHALARI



(YB-4b)
ŞERİT
DÜZENLEME
LEVHALARI



(YB-4c)
ŞERİT
DÜZENLEME
LEVHALARI



(YB-4d)
ŞERİT
DÜZENLEME
LEVHALARI



(YB-5a)
ŞERİT
DÜZENLEME
LEVHALARI



(YB-5b)
ŞERİT
DÜZENLEME
LEVHALARI



(YB-5c)
ŞERİT
DÜZENLEME
LEVHALARI



(YB-6a)
ŞERİT
DÜZENLEME
LEVHALARI



(YB-6b)
ŞERİT
DÜZENLEME
LEVHALARI



(YB-6c)
ŞERİT
DÜZENLEME
LEVHALARI

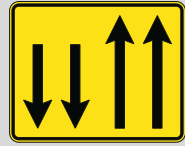

(YB-6d)
ŞERİT
DÜZENLEME
LEVHALARI



(YB-7a)
ŞERİT AKTARIMI
LEVHALARI



(YB-7b)
ŞERİT AKTARIMI
LEVHALARI



(YB-7c)
ŞERİT AKTARIMI
LEVHALARI



(YB-7d)
ŞERİT AKTARIMI
LEVHALARI

BÖLÜNMÜŞ KARAYOLLARINDA VE ÜZERİNDEKİ KAVŞAKLARDA YAPILACAK YOL YAPIM, BAKIM VE ONARIM ÇALIŞMALARINDA KULLANILACAK TRAFİK LEVHALARI



E301 BL/KVŞ



E302 BL/KVŞ



E303 BL/KVŞ



E304 BL/KVŞ



E305 BL/KVŞ



E306 BL/KVŞ



E307 BL/KVŞ



E308BL/KVŞ



E309 BL/KVŞ



E310
BL/KVŞ



E311
BL/KVŞ



E340
BL/KVŞ



İNŞ. MAK. SAN. İLETİŞİM TİC. VE TURİZM LTD. ŞTİ.

www.ermak.com.tr

e-posta: ermak@ermak.com.tr

Merkez Ofis: İlbahar Mahallesi 596. Sokak 9/2 Yıldız - Çankaya / ANKARA
Tel: 0.312 492 02 22 (pbx) Fax: 0.312 492 02 23

- Fabrika: ASO 2. ve 3. Organize Sanayi Bölgesi, Alcı OSB Mahallesi -

2024 Cadde No:10, 06930 Sincan/Ankara

Tel: 0 312 815 23 12 (pbx) Faks: 0 312 815 23 13

Seğmenler V.D. 3640046637 - Tic. Sic. No: 123136 - ATO Sicil No: 30/3471

MERSİS No:0364004663700010

Basım Yılı 2014